

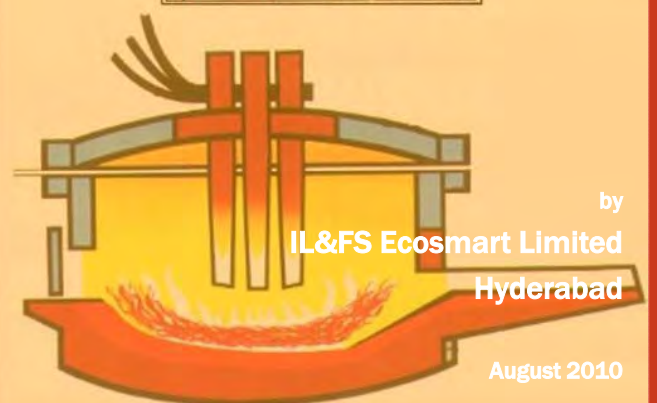

TECHNICAL EIA GUIDANCE MANUAL FOR INDUCTION, ELECTRIC ARC AND CUPOLA FURNACES

Prepared for
The Ministry of Environment and Forests
Government of India

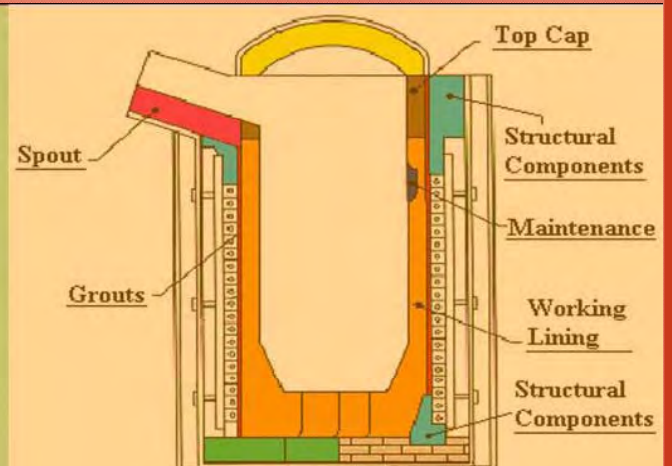
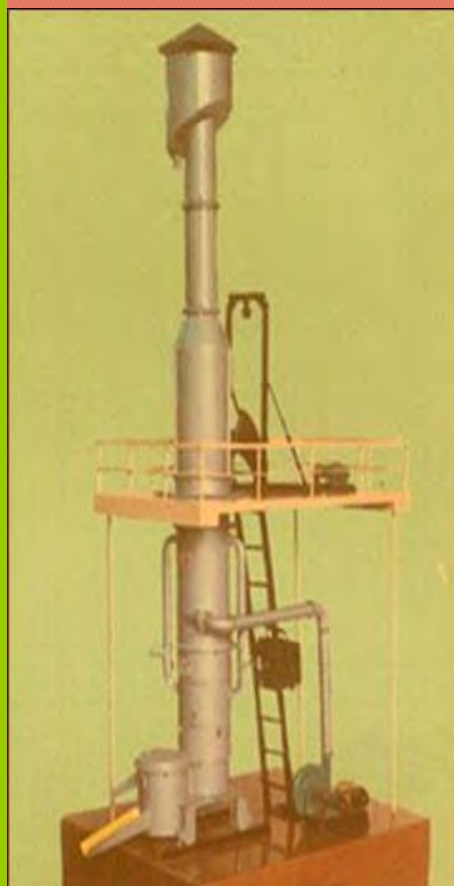

PROJECT TEAM

Project Coordination Ministry of Environment & Forests	Dr. Nalini Bhat Advisor, Ministry of Environment and Forests Dr. T. Chandni Director, Ministry of Environment and Forests
Core Project Coordination Team IL&FS Environment	Mr. Mahesh Babu CEO Mr. N. Sateesh Babu Vice President & Project Director Mr. B.S.V. Pavan Gopal Manager –Technical Mr. Vijaya Krishna. D Senior Environmental Engineer Ms. Chaitanya Vangeti Assistant Manager –Technical Ms. Suman Benedicta Thomas Technical Writer
Resource Person	Mr. K.D. Choudhury Former GM (Environment), MECON
Expert Core & Peer Committee Chairman	Dr. V. Rajagopalan, IAS Additional Secretary Ministry of Chemicals & Fertilizers
Core Members	Dr. R. K. Garg Former Chairman, EIA Committee, Ministry of Environment and Forests Mr. Paritosh C. Tyagi Former Chairman, Central Pollution Control Board Prof. S.P. Gautam Chairman, Central Pollution Control Board Dr. Tapan Chakraborti Director, National Environmental Engineering Research Institute Mr. K. P. Nyati Former Head, Environmental Policy, Confederation of Indian Industry Dr. G.K. Pandey Former Advisor, Ministry of Environment and Forests Dr. Nalini Bhat Advisor, Ministry of Environment and Forests Dr. G.V. Subramaniam Advisor, Ministry of Environment and Forests Dr. B. Sengupta Former Member Secretary, Central Pollution Control Board Dr. R. C. Trivedi Former Scientist, Central Pollution Control Board
Peer Member	Prof. S.P. Mehrotra Former Director, National Metallurgical Laboratory Professor, Department of Materials and Metallurgical Engineering Indian Institute of Technology Kanpur
Member Convener	Mr. N. Sateesh Babu Project Director

TABLE OF CONTENTS

1. INTRODUCTION TO THE TECHNICAL EIA GUIDANCE MANUALS PROJECT	1-1
1.1 Purpose.....	1-2
1.2 Project Implementation	1-4
1.3 Additional Information.....	1-4
2. CONCEPTUAL FACETS OF EIA	2-1
2.1 Environment in EIA Context.....	2-1
2.2 Pollution Control Strategies	2-2
2.3 Tools for Preventive Environmental Management.....	2-2
2.3.1 Tools for assessment and analysis	2-3
2.3.2 Tools for action.....	2-5
2.3.3 Tools for communication.....	2-10
2.4 Objectives of EIA.....	2-10
2.5 Types of EIA	2-11
2.6 Basic EIA Principles	2-12
2.7 Project Cycle	2-13
2.8 Environmental Impacts	2-13
2.8.1 Direct impacts.....	2-14
2.8.2 Indirect impacts	2-14
2.8.3 Cumulative impacts.....	2-15
2.8.4 Induced impacts.....	2-15
2.9 Significance of Impacts.....	2-16
2.9.1 Criteria/methodology to determine the significance of the identified impacts..	2-17
3. ABOUT INDUCTION/ELECTRIC ARC/CUPOLA FURNACES INCLUDING BEST PRACTICES AND POLLUTION CONTROL TECHNOLOGIES	3-1
3.1 History and Development of Induction, Electric Arc, Submerged Arc and Cupola Furnace Industry	3-2
3.1.1 Induction furnace industry.....	3-2
3.1.2 EAF industry.....	3-3
3.1.3 Cupola furnace.....	3-4
3.2 Scientific Aspects of Industrial Processes.....	3-5
3.2.1 Electric steel making	3-5
3.2.2 Non electric steel making	3-13
3.2.3 Manufacturing process in the context of environmental pollution	3-15
3.2.4 Specific consumption factors.....	3-20
3.3 Qualitative and quantitative analysis of rejects.....	3-23
3.3.1 Induction furnace.....	3-23
3.3.2 EAF.....	3-24
3.3.3 Cupola furnace.....	3-25
3.3.4 Exposure pathway.....	3-26

3.4	Technological Aspects	3-28
3.4.1	Cleaner technologies.....	3-28
3.4.2	Pollution control technologies	3-34
3.5	Summary of Applicable National Regulatory Requirements	3-37
3.5.1	General description of major statutes	3-37
3.5.2	General standards for discharge of environmental pollutants	3-38
3.5.3	Industry-specific standards	3-38
4.	OPERATIONAL ASPECTS OF EIA	4-1
4.1	Coverage of Induction/Arc/Cupola Furnaces under the Purview of the Notification	4-1
4.2	Screening	4-6
4.2.1	Applicable conditions for Category B projects.....	4-6
4.2.2	Criteria for classification of Category B1 and B2 projects.....	4-6
4.2.3	Application for prior environmental clearance	4-7
4.2.4	Siting guidelines	4-7
4.3	Scoping for EIA Studies.....	4-8
4.3.1	Pre-feasibility report	4-10
4.3.2	Guidance for providing information in Form 1	4-11
4.3.3	Identification of appropriate valued environmental components	4-11
4.3.4	Methods for identification of impacts.....	4-11
4.3.5	Testing the significance of impacts	4-17
4.3.6	Terms of reference for EIA studies	4-17
4.4	Environmental Impact Assessment	4-22
4.4.1	EIA team.....	4-23
4.4.2	Baseline quality of the environment	4-24
4.4.3	Impact prediction tools	4-27
4.4.4	Significance of the impacts.....	4-27
4.5	Social Impact Assessment	4-28
4.6	Risk Assessment.....	4-30
4.7	Mitigation Measures.....	4-34
4.7.1	Important considerations for mitigation methods.....	4-34
4.7.2	Hierarchy of elements of mitigation plan	4-35
4.7.3	Typical mitigation measures.....	4-36
4.8	Environmental Management Plan	4-39
4.9	Reporting	4-40
4.10	Public Consultation	4-41
4.11	Appraisal.....	4-44
4.12	Decision Making	4-46
4.13	Post-clearance Monitoring Protocol.....	4-47
5.	STAKEHOLDERS' ROLES AND RESPONSIBILITIES	5-1
5.1	SEIAA.....	5-3
5.2	EAC and SEAC.....	5-6

LIST OF TABLES

Table 3-1: Approximate Share of EAF & Induction Furnace (%) in total Crude Steel Production (in thousand tonnes)	3-1
Table 3-2: Production of EAF Steel.....	3-3
Table 3-3: Types of Charge Mix and their Usage in EAF Steelmaking	3-4
Table 3-4: Typical Composition of Input Materials for Induction Furnace.....	3-10
Table 3-5: Emission / Waste Generation	3-20
Table 3-6: Performance Procedure	3-22
Table 3-7: Air Emissions from Electric Arc Furnace	3-24
Table 3-8: Amount of Dust Exhausted from EAF per Tonne of Steel.....	3-25
Table 3-9: Cupola Furnace Emissions Criteria	3-26
Table 3-10: Exposure Pathways.....	3-27
Table 3-11: Comparison of High and Low Frequency Melting Furnaces	3-29
Table 3-12: Emission Monitoring Results	3-37
Table 3-13: Emission Standards - Foundries	3-38
Table 3-14: Emission Standards – Cupola Furnace	3-39
Table 3-15: OSHA standards for Permissible Noise Exposure	3-39
Table 4-1: Advantages and Disadvantages of Impact Identification Methods	4-12
Table 4-2: Matrix of Impacts	4-14
Table 4-3: List of Important Physical Environment Components and Indicators of EBM.....	4-25
Table 4-4: Choice of Models for Impact Predictions: Risk Assessment.....	4-32
Table 4-5: Typical Mitigation Measures.....	4-37
Table 4-6: Structure of EIA Report.....	4-40
Table 5-1: Roles and Responsibilities of Stakeholders Involved in Prior Environmental Clearance	5-1
Table 5-2: Organization-specific Functions.....	5-2
Table 5-3: SEIAA: Eligibility Criteria for Chairperson/ Members/ Secretary	5-5
Table 5-4: EAC/SEAC: Eligibility Criteria for Chairperson / Members / Secretary	5-8

LIST OF FIGURES

Figure 2-1: Inclusive Components of Sustainable Development.....	2-1
Figure 2-2: Types of Impacts.....	2-14
Figure 2-3: Cumulative Impact.....	2-15
Figure 3-1: Composition of Metal Production in India.....	3-2
Figure 3-2: Open Top Iron Core Induction Furnace.....	3-6
Figure 3-3: Closed Channel Iron Core Induction Furnace.....	3-7
Figure 3-4: Magnetic Field and Electro-dynamic Forces acting in the Crucible of an Induction Furnace and Electro-dynamic Circulation of Metal in the Crucible of an Induction Furnace	3-8
Figure 3-5: A Modern EAF.....	3-11
Figure 3-6: Typical Cupola Furnace.....	3-13
Figure 4-1: Categorization of Projects Under the Purview of Notification.....	4-2
Figure 4-2: Prior Environmental Clearance Process for Activities Falling Under Category A.....	4-4
Figure 4-3: Prior Environmental Clearance Process for Activities Falling Under Category B.....	4-5
Figure 4-4: Approach for EIA Study.....	4-23
Figure 4-5: Risk Assessment – Conceptual Framework.....	4-32
Figure 4-6: Comprehensive Risk Assessment - At a Glance.....	4-33
Figure 4-7: Elements of Mitigation.....	4-35

LIST OF ANNEXURES

Annexure I

A Compilation of Legal Instruments

Annexure II

General Standards for Discharge of Environmental Pollutants as per CPCB

Annexure III

Form 1 (Application Form for Obtaining EIA Clearance)

Annexure IV

Critically Polluted Industrial Areas and Clusters / Potential Impact Zone

Annexure V

Pre-feasibility Report: Points for Possible Coverage

Annexure VI

Types of Monitoring and Network Design Considerations

Annexure VII

Guidance for Assessment of Baseline Components and Attributes

Annexure VIII

Sources of Secondary Data

Annexure IX

Impact Prediction Tools

Annexure X

Form through which the State Government/Administration of the Union Territories Submit Nominations for SEIAA and SEAC for the Consideration and Notification by the Central Government.

Annexure XI

Composition of EAC/SEAC

Annexure XII

Best Practices & Latest Technologies available and reference

ACRONYMS

AAQ	Ambient Air Quality
B/C	Benefits Cost Ratio
BAT	Best Available Technology
BOD	Biological Oxygen Demand
BOQ	Bill of Quantities
BOT	Build Operate Transfer
CCA	Conventional Cost Accounting
CER	Corporate Environmental Reports
CEAA	Canadian Environmental Assessment Agency
CFE	Consent for Establishment
CO	Carbon Monoxide
CPCB	Central Pollution Control Board
CREP	Corporate Responsibility for Environmental Protection
CRZ	Coastal Regulatory Zone
DMP	Disaster Management Plan
DRI	Direct Reduced Iron
EAC	Expert Appraisal Committee
EAF	Electric Arc Furnace
ECI	Environmental Condition Indicators
EcE	Economic-cum-Environmental
EIA	Environmental Impact Assessment
EIS	Environmental Information System
EMA	Environmental Management Accounting
EMP	Environmental Management Plan
EMS	Environmental Management System
EPI	Environmental Performance indicators
EPZ	Export Processing Zones
ES	Environmental Statements
ESP	Electrostatic Precipitator
ETP	Effluent Treatment Plant
FCA	Full Cost Assessment
FUCHS	Post Consumption Shaft Furnace
HAZOP	Hazard and Operability Studies
HBI	Hot Briquetted Iron
HTL	High Tide Level

IF	Induction Furnace
IL&FS	Infrastructure Leasing & Financial Services Limited
IVI	Importance Value Index
ISO	International Standard Organization
JPC	Joint Plant Commission of Ministry of Steel
LCA	Life Cycle Assessment
LDAR	Leak Detection and Repair
LTL	Low Tide Level
MCA	Maximum Credible Accident
MoEF	Ministry of Environment & Forests
MT	Million (metric) tons
NAQM	National Air Quality Monitoring
O&M	Operation and Maintenance
OECD	Organization for Economic Co-operation and Development
PAH	Polynuclear Aromatic Hydrocarbons
PCB	Polychlorinated Biphenyls
PM	Particulate Matter
PPA	Participatory Poverty Assessment
PRA	Participatory Rural Appraisal
QA/QC	Quality Assurance/Quality Control
QRA	Quantitative Risk Assessment
SEA	Strategic Environmental Assessment
SEAC	State Level Expert Appraisal Committee
SEIAA	State Level Environment Impact Assessment Authority
SEZ	Special Economic Zone
SIA	Social Impact Assessment
SPCB	State Pollution Control Board
SPM	Suspended Particulate Matter
TA	Technology Assessment
TCA	Total Cost Assessment
TEQM	Total Environmental Quality Movement
TGM	Technical EIA Guidance Manual
ToR	Terms of Reference
UT	Union Territory
UTEIAA	Union Territory Level Environment Impact Assessment Authority
UTPCC	Union Territory Pollution Control Committee
VOC	Volatile Organic Compound

Mahesh Babu
Chief Executive Officer

Acknowledgement

The Notification issued on the prior environmental clearance process by the Ministry of Environment and Forests (MoEF) on September 14, 2006 delegated substantial powers to the State Level Environment Impact Assessment Authorities (SEIAA) to grant environmental clearance for certain categories of developmental activities/projects. It was felt that proper guidance to the stakeholders would enhance appreciation of environmental impacts of proposed projects and possible mitigation measures. Further, such a guidance would also help ensure that decision making authorities across different States and Union Territories could adopt similar considerations and norms with due weightage for site-specific considerations.

We feel privileged to be part of the interventions being spearheaded by Sh. Jairam Ramesh, Hon'ble Minister, MoEF, Government of India, to mainstream environmental considerations in the decision making process. IL&FS Ecosmart as part of this important initiative, prepared Technical EIA Guidance Manuals for 27 identified development activities. In view of the diversity of 27 developmental activities entrusted to IL&FS Ecosmart Ltd., in consultation with the MoEF, an expert Peer and Core Committee was constituted to review and finalize each of the draft Manuals. The Manuals prepared by IL&FS were technically reviewed and up-dated by the respective sector-specific expert resource persons.

The Manuals designed by the Expert Committee have benefitted from the advise and feedback received from MoEF. The Manuals are designed to provide readers with an in-depth understanding of the environmental clearance mechanism, developmental activity specific environmental impacts with possible mitigation measures, environmentally compliant manufacturing/ production processes and pollution control technologies, etc.

IL&FS Ecosmart hopes that these Manuals are a step forward to realize the MoEF's desired objective of enhancing functional efficiency and effectiveness in the environmental clearance process. We hope the stakeholders will find the Manuals useful.

We take this opportunity to convey our appreciation to the MoEF team under the leadership of Mr. J.M. Mauskar, Additional Secretary, for the technical inputs, guidance and support extended throughout the project period for successful completion of the project. The technical guidance and support extended by the Expert Peer and Core Committee under the Chairmanship of Dr. V. Rajagopalan, former Chairman, Central Pollution Control Board and inputs of the sector-specific resource persons are gratefully acknowledged.

(Mahesh Babu)

15th November 2010



22nd December 2010

FOREWORD

The Ministry of Environment & Forests (MOEF) introduced the Environmental Impact Assessment (EIA) Notification 2006 on 14th September 2006, which not only reengineered the entire environment clearance (EC) process specified under the EIA Notification 1994, but also introduced a number of new developmental sectors which would require prior environmental clearance. The EIA Notification 2006 has notified a list of 39 developmental sectors which have been further categorised as A or B based on their capacity and likely environmental impacts. Category B projects have been further categorised as B1 and B2. The EIA Notification 2006 has further introduced a system of screening, scoping and appraisal and for the setting up of Environment Impact Assessment Authority (EIAA) at the Central level and State Level Environment Impact Assessment Authorities (SEIAAs) to grant environmental clearances at the Central and State level respectively. The Ministry of Environment & Forests is the Environment Impact Assessment Authority at the Central level and 25 State Level Environment Impact Assessment Authorities (SEIAAS) have been set up in the various States/UTs. The EIA Notification 2006 also stipulates the constitution of a multi-disciplinary Expert Appraisal Committee (EAC) at the Centre and State level Expert Appraisal Committees (SEACs) at State/UT Level for appraisal of Category A or B projects respectively and to recommend grant/rejection of environmental clearance to each project/activities falling under the various sectors to the EIAA/SEIAAs respectively.

Although the process of obtaining environmental clearance consisting of Screening, Scoping and Appraisal and for undertaking public consultation including the process of conduct of Public Hearing has been elaborated under the EIA Notification 2006, the Notification itself provides for bringing out guidelines from time to time on the EIA Notification 2006 and the EC process with a view to bringing clarity on the EC process for expediting environmental clearance. This need was further reinforced after the constitution of SEIAAs and SEACs in various States, who were assigned the task for the first time and for addressing the concerns of standardization of the quality of appraisal and in reducing inconsistencies between SEACs/SEIAAs in granting ECs for similar projects in different States.

The Technical Guidance Manual of "Induction, Electric Arc And Cupola Furnaces" sector describes types of process and pollution control technologies, operational aspects of EIA with model TOR of that Sector, technological options with cleaner production and waste minimization techniques, monitoring of environmental quality, post clearance monitoring

protocol, related regulations, and procedure of obtaining EC if linked to other clearances for e.g., CRZ, etc.

Steel melting in EAF or induction furnace uses large quantities of raw materials, energy and water. These need to be managed well in order to maximize productivity and profits. As such, improving energy and resource efficiency should be approached from several directions. A strong corporate-wide energy and resource management program is essential. India's industrial competitiveness and environmental future depends on Industries such as Induction, Electric Arc and Cupola Furnaces adopting energy and resource efficient technologies. Recycling and reuse of materials is critical.

To keep pace with changing technologies and needs of sustainable development, the manual would require regular updating in the future. The manual will be available on the MoEF website and we would appreciate receiving responses from stakeholders for further improvements.

I congratulate the entire team of IL&FS Ecosmart Ltd., experts from the sector who were involved in the preparation of the Manuals, Chairman and members of the Core and Peer Committees of various sectors and various Resource Persons whose inputs were indeed valuable in the preparation and finalization of the Manuals.



(Jairam Ramesh)

1. INTRODUCTION TO THE TECHNICAL EIA GUIDANCE MANUALS PROJECT

Environmental Impact Assessment (EIA) is a process of identifying, predicting, evaluating and mitigating the biophysical, social, and other relevant effects of development proposals prior to major decisions being taken and commitments made. These studies integrate the environmental concerns of developmental activities into the process of decision-making.

EIA has emerged as one of the successful policy innovations of the 20th Century in the process of ensuring sustained development. Today, EIA is formalized as a regulatory tool in more than 100 countries for effective integration of environmental concerns in the economic development process. The EIA process in India was made mandatory and was also given a legislative status through a Notification issued by the Ministry of Environment and Forests (MoEF) in January 1994. The Notification, however, covered only a few selected industrial developmental activities. While there are subsequent amendments, the Notification issued on September 14, 2006 supersedes all the earlier Notifications, and has brought out structural changes in the clearance mechanism.

The basic tenets of this EIA Notification could be summarized into the following:

- Pollution potential as the basis for prior environmental clearance instead of investment criteria; and
- Decentralization of clearing powers to the State/Union Territory (UT) level Authorities for certain developmental activities to make the prior environmental clearance process quicker, transparent and effective.

Devolution of the power to grant clearances at the state level for certain category of the developmental activities / projects is a step forward to fulfill the basic tenets of the re-engineering *i.e.*, quicker, transparent and effective process but many issues impede/hinder its functional efficiency. These issues could be in technical and operational domains as listed below:

Technical issues

- Ensuring level playing ground to avoid arbitrariness in the decision-making process
- Classification of projects which do not require public hearing and detailed EIA (Category B2)
- Variations in drawing Terms of Reference (ToR) of EIA studies for a given developmental activity across the States/UTs
- Varying developmental-activity-specific expertise requirement for conducting EIA studies and their appraisal
- Availability of adequate sectoral experts and variations in competency levels
- Inadequate data verification, cross checking tools and supporting institutional framework

- Meeting time targets without compromising with the quality of assessments/ reviews
- Varying knowledge and skill levels of regulators, consultants and experts
- Newly added developmental activities for prior environmental clearance, *etc.*

Operational issues

- State level /UT level EIA Authorities (SEIAA/UTEIAA) are formulated for the first time and many are functioning
- Varying roles and responsibilities of involved organizations
- Varying supporting institutional strengths across the States/UTs
- Varying manpower availability, *etc.*

1.1 Purpose

The purpose of developing the sector-specific technical EIA guidance manuals (TGM) is to provide clear and concise information on EIA to all the stakeholders *i.e.*, the project proponent, the consultant, the reviewer, and the public. The TGMs are organized to cover following:

Chapter 1 (Introduction): This chapter provides a brief introduction on the EIA, basic tenets of EIA Notification, technical & operational issues in the process of clearance, purpose of the TGMs, project implementation process and additional information.

Chapter 2 (Conceptual facets of an EIA): Provides an overall understanding to the conceptual aspects of control of pollution and EIA for the developmental projects. This basic understanding would set the readers at same level of understanding for proper interpretations and boundaries for identifying the environmental interactions of the developmental projects and their significance for taking measures of mitigation. This chapter covers the discussion on environment in EIA context *i.e.*, sustainable development, pollution control strategies, preventive environmental management tools, Objectives of EIA, types and basic principles of EIA, project cycle for induction/arc/cupola furnace industry, understanding on type of environmental impacts and the criteria for the significance analysis.

Chapter 3 (Induction/arc/cupola furnace industry): The purpose of this chapter is to provide the reader precise information on all the relevant aspects of the industry, which is essential to realize the likely interaction of such developmental activities on the receiving environment. Besides, this Chapter gives a holistic understanding on the sources of pollution and the opportunities of the source control.

The specific coverage which provides precise information on the industry include (i) introduction to history and development of the industry in India, (ii) Scientific aspects of industrial process – electric steel making, Non electric steel making, Manufacturing process in the context of environmental pollution, Specific consumption factors, Qualitative and quantitative analysis of rejects, Exposure pathway, (iii) cleaner and pollution control technologies, and (iv) the summary of applicable national regulation for this developmental activity.

Chapter 4 (Operational aspects): The purpose of this chapter is to facilitate the stakeholders to extend clear guidance on coverage of legislative requirements, sequence of procedures for obtaining the EIA clearance and each step-wise provisions and considerations.

The coverage of the Chapter include provisions in the EIA Notification regarding induction/electric arc/cupola furnace industry, screening (criteria for categorization of B1 and B2, siting guidelines, *etc.*), scoping (pre-feasibility report, guidance for filling form 1, identification of valued environmental components, identification of impacts, *etc.*), arriving at terms of reference for EIA studies, impact assessment studies (EIA team, assessment of baseline quality of environment, impact prediction tools, significance of impacts), social impact assessment, risk assessment considerations, typical mitigation measures, designing considerations for environmental management plan, structure of EIA report for incorporation of study findings, process of public consultation, project appraisal, decision making process and post-clearance monitoring protocol.

Chapter 5 (Roles and responsibilities of various organizations involved in the process of prior environmental clearance): The purpose of this Chapter is to brief the stakeholders on the institutional mechanism and roles & responsibilities of the stakeholders involved in the process of prior environmental clearance. The Coverage of the Chapter include (i) roles and responsibilities of the stakeholders, (ii) organization specific functions, (iii) constitution, composition and decision making process of SEIAA and (iv) EAC & SEAC and (v) other conditions which may be considered.

For any given industry, each topic listed above could alone be the subject of a lengthy volume. However, in order to produce a manageable document, this project focuses on providing summary information for each topic. This format provides the reader with a synopsis of each issue. Text within each section was researched from many sources, and was condensed from more detailed sources pertaining to specific topics.

The contents of the document are designed with a view to facilitate addressing of the relevant technical and operational issues as mentioned in the earlier section. Besides, it facilitates various stakeholders involved in the EIA clearance process *i.e.*,

- Project proponents will be fully aware of the procedures, common ToR for EIA studies, timelines, monitoring needs, *etc.*, in order to plan the projects/studies appropriately.
- Consultants across India will gain similar understanding about a given sector, and also the procedure for EIA studies, so that the quality of the EIA reports gets improved and streamlined
- Reviewers across the states/UTs will have the same understanding about an industry sector and would able to draw a benchmark in establishing the significant impacts for the purpose of prescribing the ToR for EIA studies and also in the process of review and appraisal.
- Public who are concerned about new or expansion projects, use this manual to get a basic idea about the manufacturing/production details, rejects/wastes from the operations, choice of cleaner/control technologies, regulatory requirements, likely environmental and social concerns, mitigation measures, *etc.*, in order to seek clarifications appropriately in the process of public consultation. The procedural clarity in the document will further strengthen them to understand the stages involved in clearance and roles and responsibilities of various organizations.
- In addition, these manuals would substantially ease the pressure on reviewers at the scoping stage and would bring in functional efficiency at the central and state levels.

1.2 Project Implementation

The Ministry of Environment & Forests (MoEF), Government of India took up the task of developing sector-specific technical EIA guidance manuals for all the developmental activities listed in the re-engineered EIA Notification. The Infrastructure Leasing and Financial Services Ecosmart Limited (IL&FS Ecosmart), has been entrusted with the task of developing these manuals for 27 industrial and related sectors as mentioned in the Schedule attached to the EIA Notification issued on September 14, 2006. Now, after amendment of the EIA notification as on 1st December, 2009, induction and electric arc furnace, submerged arc furnace and cupola with capacity more than 30,000 tonnes per annum (TPA), have been listed in item 3(a), column 5, which requires environmental clearance under metallurgical industries. This manual is prepared specially for induction, electric arc and cupola furnaces.

The ability to design comprehensive EIA studies for specific industries depends on the knowledge of several interrelated topics. Therefore, it requires expert inputs from multiple dimensions *i.e.*, administrative, project management, technical, scientific, social, economic, risk *etc.*, in order to comprehensively analyze the issues of concern and to draw logical interpretations. Thus, Ecosmart has designed a well-composed implementation framework to factor inputs of the experts and stakeholders in the process of finalization of these manuals.

The process of manual preparation involved collection & collation of the secondary available information, technical review by sectoral resource persons and critical review & finalization by a competent Expert Committee composed of core and sectoral peer members.

The MoEF appreciates the efforts of Ecosmart, Expert Core and Peer Committee, resource persons and all those who have directly and indirectly contributed to this Manual.

1.3 Additional Information

This TGM is brought out by the MoEF to provide clarity to all the stakeholders involved in the 'Prior Environmental Clearance' process. As such, the contents and clarifications given in this document do not withstand in case of a conflict with the statutory provisions of the Notifications and Executive Orders issued by the MoEF from time-to-time.

TGMs are not regulatory documents. Instead, these are the tools designed to assist in successful completion of an EIA. For the purpose of this project, the key elements considered under TGMs are: conceptual aspects of EIA; developmental activity-specific information; operational aspects; and roles and responsibilities of involved stakeholders.

This manual is prepared considering the Notification issued on September 14, 2006 and latest amendment of 1st December 2009. For recent updates, if any, please refer the website of the MoEF, Government of India *i.e.*, <http://moef.nic.in/index.php>

2.

CONCEPTUAL FACETS OF EIA

It is an imperative requirement to understand the basic concepts concerned to the pollution control and the environmental impact assessment in an overall objective of the sustainable development. This Chapter highlights the pollution control strategies and their tools besides the objectives, types & principles of EIA, type of impacts their significance analysis, in order to provide consistent understanding to the reader before assessing the development of activity-specific environmental concerns in Chapter 3 and identification & prediction of significant impacts in order to design mitigation measures as detailed in Chapter 4.

2.1 Environment in EIA Context

“Environment” in EIA context mainly focuses, but is not limited to physical, chemical, biological, geological, social, economical, and aesthetic dimensions along with their complex interactions, which affect individuals, communities and ultimately determines their forms, character, relationship, and survival. In EIA context, ‘effect’ and ‘impact’ can often be used interchangeably. However, ‘impact’ is considered as a value judgment of the significance of an effect.

Sustainable development is built on three basic premises *i.e.*, economic growth, ecological balance and social progress. Economic growth achieved in a way that does not consider the environmental concerns, will not be sustainable in the long run. Therefore, sustainable development needs careful integration of environmental, economic, and social needs in order to achieve both an increased standard of living in short term, and a net gain or equilibrium among human, natural, and economic resources to support future generations in the long term.

“It is necessary to understand the links between environment and development in order to make choices for development that will be economically efficient, socially equitable and responsible, as well as environmentally sound.” Agenda 21, Rio Declaration on Environment and Development, Rio De Janerio, June 1992.

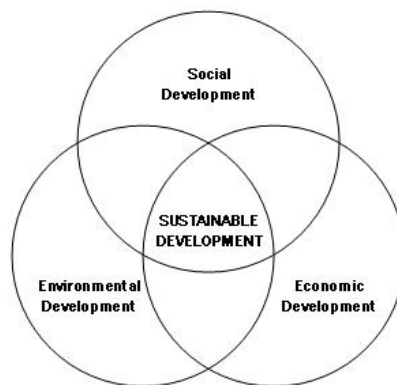

Figure 2-1: Inclusive Components of Sustainable Development

2.2 Pollution Control Strategies

Pollution control strategies can be broadly categorized into preventive and reactive. The reactive strategy refers to the steps that may be applied once the wastes are generated or contamination of the receiving environment takes place. The control technology or a combination of technologies to minimize the impact due to the process rejects/wastes varies with quantity and characteristics, desired control efficiency and economics.

Many combinations of techniques could be adopted for treatment of a specific waste or the contaminated receiving environment, but are often judged based on techno-economic feasibility. Therefore, the best alternative is to take all possible steps to avoid pollution itself. This preventive approach refers to a hierarchy that involves i) prevention & reduction; ii) recycling and re-use; iii) treatment; and iv) disposal, respectively.

Therefore, there is a need to shift the emphasis from the reactive to preventive strategy *i.e.*, to promote preventive environmental management. Preventive environmental management tools may be grouped into management based tools, process based tools and product based tools, which are given below:

Management Based Tools	Process Based Tools	Product Based Tools
Environmental Management System (EMS)	Environmental Technology Assessment	Industrial Ecology
Environmental Performance Evaluation	Toxic Use Reduction	Extended Producers Responsibility
Environmental Audits	Best Operating Practices	Eco-labeling
Environmental Reporting and Communication	Environmentally Best Practice	Design for Environment
Total Cost Accounting	Best Available Technology (BAT)	Life Cycle Assessment (LCA)
Law and Policy	Waste Minimization	
Trade and Environment	Pollution Prevention	
Environmental Economics	Cleaner Production	
	4-R Concept	
	Cleaner Technology	
	Eco-efficiency	

2.3 Tools for Preventive Environmental Management

The tools for preventive environmental management can be broadly classified into following three groups.

- Tools for assessment and analysis - risk assessment, life cycle assessment, total cost assessment, environmental audit / statement, environmental benchmarking, environmental indicators
- Tools for action - environmental policy, market based economic instruments, innovative funding mechanism, EMS and ISO certification, total environmental quality movement, eco-labeling, cleaner production, eco-efficiency, industrial ecosystem or metabolism, voluntary agreements
- Tools for communication - state of environment, corporate environmental reporting

Specific tools under each group are discussed precisely in next sections.

2.3.1 Tools for assessment and analysis

2.3.1.1 Risk assessment

Risk is associated with the frequency of failure and consequence effect. Predicting such situations and evaluation of risk is essential to take appropriate preventive measures. The major concern of the assessment is to identify the activities falling in a matrix of high & low frequencies at which the failures occur and the degree of its impact. The high frequency, low impact activities can be managed by regular maintenance *i.e.*, LDAR (Leak detection and repair) programmes. Whereas, the low frequency, high impact activities are of major concern (accidents) in terms of risk assessment. As the frequency is low, often the required precautions are not realized or maintained. However, risk assessment identifies the areas of major concerns which require additional preventive measures; likely consequence distances considering domino effects, which will give the possible casualties and ecological loss in case of accidents. These magnitudes demand the attention for preventive and disaster management plans (DMP). Thus is an essential tool to ensure safety of operations.

2.3.1.2 Life cycle assessment

A broader approach followed to deal with environmental impacts during manufacturing is called LCA. This approach recognizes that environmental concerns are associated with every step of the processing w.r.t. manufacturing of products and also examines environmental impacts of the product at all stages of the project life cycle. LCA includes product design, development, manufacturing, packaging, distribution, usage and disposal. LCA is concerned with reducing environmental impacts at all the stages and considering the total picture rather than just one stage of the production process.

Industries/firms may apply this concept to minimize costs incurred on the environmental conservation throughout the project life cycle.

2.3.1.3 Total cost assessment

Total Cost Assessment (TCA) is an enhanced financial analysis tool that is used to assess the profitability of alternative courses of action *e.g.*, raw material substitution to reduce the costs of managing the wastes generated by process; an energy retrofit to reduce the costs of energy consumption. This is particularly relevant for pollution prevention options. These options, because of their nature, often produce financial savings that are overlooked in conventional financial analysis, either because they are misallocated, uncertain, hard to quantify, or occur more than three to five years after the initial investment. TCA includes all relevant costs and savings associated with an option so that it can compete for scarce capital resources fairly, on a level playing field. The assessments are often beneficial w.r.t the following:

- Identification of costly resource inefficiencies
- Financial analysis of environmental activities/projects such as investment in cleaner technologies
- Prioritization of environmental activities/projects
- Evaluation of product mix and product pricing
- Bench marking against the performance of other processes or against the competitors

A comparison of cost assessments is given below:

- Conventional cost accounting (CCA): Direct and indirect financial costs+ Recognized contingent costs
- Total Cost Assessment (TCA): A broader range of direct, indirect, contingent and less quantifiable costs
- Full Cost assessment (FCA): TCA + External social costs borne by society

2.3.1.4 Environmental audit/statement

Key objectives of an environmental audit includes compliance verification, problem identification, environmental impact measurement, environmental performance measurement, conforming effectiveness of EMS, providing a database for corrective actions and future actions, developing company's environmental strategy, communication and formulating environmental policy.

The MoEF, Government of India issued Notification on 'Environmental Statements' (ES) in April, 1992 and further amended in April 1993 – As per the Notification, the industries are required to submit environmental statements to the respective State Pollution Control Board (SPCB). ES is a proactive tool for self-examination of the industry to reduce/minimize pollution by adopting process modifications, recycling and reusing of the resources. The regular submission of ES will indicate the systematic improvement in environmental pollution control being achieved by the industry. In other way, specific points in ES may be used as environmental performance indicators for relative comparison, implementation and to promote better practices.

2.3.1.5 Environmental benchmarking

Environmental performance and operational indicators could be used to navigate, manage and communicate the significant aspects and give enough evidence of good environmental house keeping. Besides the existing prescribed standards, an insight to identify the performance indicators and prescribing schedule for systematic improvement in performance of these indicators will yield better results.

Relative indicators may be identified for different industrial sectors and be integrated in companies and organizations to monitor and manage the different environmental aspects of the company, to benchmark and compare two or more companies from the same sector. These could cover water consumption, wastewater generation, energy consumption, solid/hazardous waste generation, chemical consumption *etc.*, per tonne of final product. Once these bench marks are developed, the industries which are below them may be guided and enforced to reach them while those which are better than the benchmark may be encouraged further by giving incentives *etc.*

2.3.1.6 Environmental indicators

Indicators can be classified in to environmental performance indicators (EPI) and environmental condition indicators (ECI). The EPIs can be further divided into two categories *i.e.*, operational performance indicators and management performance indicators.

The operational performance indicators are related to the process and other operational activities of the organization. These would typically address the issue of raw material consumption, energy consumption, water consumption in the organization, the quantities of wastewater generated, other solid wastes & emissions generated from the organization *etc.*

Management performance indicators are related to the management efforts to influence the environmental performance of the organisational operations.

The environmental condition indicators provide information about the environment. These indicators provide information about the local, regional, national or global condition of the environment. This information helps an organization to understand the environmental impacts of its activities and thus helps in taking decisions to improve the environmental performance.

Indicators basically used to evaluate environmental performance against the set standards and thus indicate the direction in which to proceed. Selection of type of indicators for a firm or project depends upon its relevance, clarity and realistic cost of collection and its development.

2.3.2 Tools for action

2.3.2.1 Environmental policy

An environmental policy is a statement of an organization's overall aim and principles of action w.r.t the environment, including compliance with all relevant regulatory requirements. It is a key tool in communicating environmental priorities of the organization to all its employees. To ensure organization's commitment towards a formulated environmental policy, it is essential for the top management to be involved in the process of formulating the policy and setting priorities. Therefore, the first step is to get the commitment from the higher levels of management. The organization should then conduct an initial environmental review and draft an environmental policy. This draft should be discussed and approved by the board of directors. The approved environmental policy statement, should then be communicated internally among all its employees and must also be made available to the public.

The Ministry of Environment & Forests, Government of India published the National Environment Policy, thus the individual firms while making their environmental policies may like to refer the national environment policy for synchronization

2.3.2.2 Market-based economic instruments

Market based instruments are regulations that encourage behavior through market signals rather than through explicit directives regarding pollution control levels. These policy instruments such as tradable permits, pollution charge are often described as harnessing market forces. Market based instruments can be categorized into the following four major categories which are discussed below.

- **Pollution charge:** Charge system will assess a fee or tax on the amount of pollution a firm or source generates. It is worthwhile for the firm to reduce emissions to the point, where its marginal abatement costs is equal to the tax rate. Thus firms control pollution to different degrees *i.e.* High cost controllers – less; low-cost controllers – more. The charge system encourages the industries to further reduce the pollutants. The collected charges can form a fund for restoration of the environment. Another form of pollution charge is a deposit refund system, where, consumers pay a surcharge when purchasing a potentially polluting product, and receive a refund on return of the product after useful life span at appropriate centers. The concept of

extended producers' responsibility brought in to avoid accumulation of dangerous products in the environment.

- **Tradable permits:** Under this system, firms that achieve the emission levels below their allotted level may sell the surplus permits. Similarly, the firms, which are required to spend more to attain the required degree of treatment/allotted levels, can purchase permits from others at lower costs and may be benefited.
- **Market barrier reductions:** Three known market barrier reduction types are as follows:
 - Market Creation: Measures that facilitate the voluntary exchange of water rights and thus promote more efficient allocation of scarce water supplies
 - Liability Concerns: Encourage firms to consider potential environmental damages of their decisions
 - Information Programmes: Eco-labeling and energy- efficiency product labeling requirements
- **Government subsidy reduction:** Subsidies are the mirror images of taxes and, in theory, can provide incentive to address environmental problems. However, it has been reported that the subsidies encourage economically inefficient and environmentally unsound practices, and often leads to market distortions due to differences in the area. However, these are important to sustain the expansion of production, in the national interests. In such cases, the subsidy may be comparable to the net social benefit.

2.3.2.3 Innovative funding mechanism

There are many forums under which the fund is made available for the issues which are of global/regional concern *i.e.*, climate change, Basal Convention and further fund sources are being explored for the Persistent Organic Pollutants Convention. Besides the global funding mechanism, there needs to be localized alternative mechanisms for boosting the investment in environmental pollution control. For example, in India the Government has established mechanism to fund the common effluent treatment plants, which are specifically serving the small and medium scale enterprises *i.e.*, 25% share by the State Government, matching grants from the Central Government and surety for 25% soft loan. It means that the industries need to invest only 25% initially, thus encouraging voluntary compliance.

There are some more options *i.e.*, if the pollution tax/charge is imposed on the residual pollution being caused by the industries, municipalities *etc.*, fund will automatically be generated, which in turn, can be utilized for funding the environmental improvement programmes. The emerging concept of build-operate-transfer (BOT) is an encouraging development, where there is a possibility to generate revenue by application of advanced technologies. There are many opportunities which can be explored. However, what is required is the paradigm shift and focused efforts.

2.3.2.4 EMS and ISO certification

EMS is that part of the overall management system, which includes the organizational structure, responsibilities, practices, procedures, process and resources for determining and implementing the forms of overall aims, principles of action w.r.t the environment. It encompasses the totality of organizational, administrative and policy provisions to be taken by a firm to control its environmental influences. Common elements of an EMS are

the identification of the environmental impacts and legal obligations, the development of a plan for management & improvement, the assignment of the responsibilities and monitoring of the performance.

2.3.2.5 Total environmental quality movement

Quality is regarded as

- A product attribute that had to be set at an acceptable level and balanced against the cost
- Something delivered by technical systems engineered by experts rather than the organization as a whole
- Assured primarily through the findings and correction of mistakes at the end of the production process

One expression of the total environment quality movement (TEQM) is a system of control called Kaizen. The principles of Kaizen are:

- Goal must be continuous improvement of quality instead of acceptable quality
- Responsibility of the quality shall be shared by all members of an organization
- Efforts should be focused on improving the whole process and design of the products

With some modifications, TEQM approach can be applied in the improvement of corporate environmental performance in both process and product areas.

2.3.2.6 Eco-labeling

Eco-labeling is the practice of supplying information on the environmental characteristics of a product or service to the general public. These labeling schemes can be grouped into three types:

- Type I: Multiple criteria base; third party (Govt. or non-commercial private organizations) programme claims overall environmental preferability.
- Type II: Specific attribute of a product; often issued by a company/industrial association
- Type III: Agreed set of indices; provide quantified information; self declaration

Among the above, Type I are more reliable because they are established by a third party and considers the environmental impacts of a product from cradle to grave. However, the labeling program will only be effective if linked with complementary program of consumer education and up on restriction of umbrella claims by the producers.

2.3.2.7 Cleaner production

Cleaner production is one of the tools, which has lot of bearing on environmental pollution control. It is also seen that the approach is changing with time *i.e.*, dumping-to-control-to-recycle-to-prevention. Promotion of cleaner production principles involve an insight into the production processes not only to get desired yield but also to optimize on raw material consumption *i.e.*, resource conservation and implications of the waste treatment and disposal.

2.3.2.8 4-R concept

The concept endorses utilization of wastes as a by-product to the extent possible *i.e.*, Re-cycle, Recover, Reuse, Recharge. Recycling refers to using wastes/by-products in the process again as a raw material to maximize production. Recovery refers to engineering means such as solvent extraction, distillation, precipitation *etc.* to separate the useful constituents of wastes, so that these recovered materials can be used. Re-use refers to the utilization of waste from one process as a raw material to other. Recharging is an option in which the natural systems are used for renovation of waste for further use.

2.3.2.9 Eco-efficiency

The World Business Council on sustainable development (WBCSD) defines eco-efficiency as “the delivery of competitively priced goods and services that satisfy human needs and bring quality of life, while progressively reducing ecological impacts and resource intensity throughout the life cycle, to a level at least in line with earth’s carrying capacity”. The business implements the eco-efficiency on four levels *i.e.* optimized processes, recycling of wastes, eco-innovation and new services. Fussler (1995) defined six dimensions of eco efficiency, which are given below to understand/examine the system.

- **Mass:** There is an opportunity to significantly reduce mass burdens (raw materials, fuels, utilities consumed during the life cycle)
- **Reduce Energy Use:** The opportunity is to redesign the product or its use to provide significant energy savings
- **Reduce Environmental Toxins:** This is concern to the environmental quality and human health. The opportunity here is to significantly control the dispersion of toxic elements.
- **Recycle when Practical:** Designing for recyclability is important
- **Working with Mother Nature:** Materials are borrowed and returned to the nature without negatively affecting the balance of the ecosystem
- **Make it Last Longer:** It relates to useful life and functions of products. Increasing the functionality of products also increase their eco efficiency

The competitiveness among the companies and long-term survival will continue and the successful implementation of eco efficiency will contribute to their success. There is a need to shift towards responsible consumerism equal to the efficiency gains made by corporations – doing more with less.

2.3.2.10 Industrial ecosystem or metabolism

Eco-industrial development is a new paradigm for achieving excellence in business and environmental performance. It opens up innovative new avenues for managing business and conducting economic development by creating linkages among local ‘resources’, including businesses, non-profit groups, governments, unions, educational institutions, and communities. They can creatively foster the dynamic and responsible growth. Antiquated business strategies based on isolated enterprises are no longer responsive enough to market, environmental and community requirements.

Sustainable eco-industrial development looks systematically at development, business and environment, attempting to stretch the boundaries of current practice - on one level. It is as directly practical as making the right connections between the wastes and resources needed for production and at the other level, it is a whole new way of thinking about doing business and interacting with communities. At a most basic level, it is each organization seeking higher performance within it self. However, most eco-industrial activity is moving to a new level by increasing the inter connections between the companies.

Strategic partnership, networked manufacturing and performed supplier arrangements are all the examples of ways used by the businesses to ensure growth, contain costs and to reach out for new opportunities.

For most businesses, the two essentials for success are the responsive markets and access to cost-effective, quality resources for production or delivering services. In absence of these two factors, virtually every other incentive becomes a minor consideration.

Transportation issues are important at two levels, the ability to get goods to market in an expeditious way is essential to success in this day of just in time inventories. The use of least impact transportation with due consideration of speed and cost supports business success and addresses the concerned in community.

Eco-industrial development works because it consciously mixes a range of targeted strategies shaped to the contours of the local community. Most importantly, it works because the communities want nothing less than the best possible in or near their neighborhoods. For companies, it provides a path towards significantly higher operating results and positive market presence. For our environment, it provides great hope that the waste will be transformed into valued product and that the stewardship will be a joint pledge of both businesses and communities.

2.3.2.11 Voluntary agreements

Voluntary environmental agreements among the industries, government, public representatives, NGOs and other concerned towards attaining certain future demands of the environment are reported to be successful. Such agreements may be used as a tool where Government would like to make the standards stringent in future (phase-wise-stringent). These may be used when conditions are temporary and require timely replacement. Also these may be used as supplementary/ complimentary in implementation of the regulation. The agreements may include:

- Target objectives (emission limit values/standards)
- Performance objectives (operating procedures)
- R&D activities – Government and industry may have agreement to establish better control technologies.
- Monitoring & reporting of the agreement conditions by other agents (NGOs, public participants, civil authority *etc.*)

In India, the MoEF has organized such programme, popularly known as the corporate responsibility for environment protection (CREP) considering identified 17 categories of high pollution potential industrial sectors. Publication in this regard, is available with Central Pollution Control Board (CPCB).

2.3.3 Tools for communication

2.3.3.1 State of environment

The Government of India has brought out the state of environment report for entire country and similar reports available for many of the states. These reports are published at regular intervals to record trends and to identify the required interventions at various levels. These reports consider the internationally accepted DPSIR framework for the presentation of the information. DPSIR refers to

- D – Driving forces – causes of concern *i.e.* industries, transportation *etc.*
- P – Pressures – pollutants emanating from driving forces *i.e.* emission
- S – State – quality of environment *i.e.* air, water & soil quality
- I – Impact – Impact on health, ecosystem, materials, biodiversity, economic damage *etc.*
- R – Responses – action for cleaner production, policies (including standards/guidelines), targets *etc.*

Environment reports including the above elements gives a comprehensive picture of specific target area in order to take appropriate measures for improvement. Such reports capture the concerns, which could be considered in EIAs.

2.3.3.2 Corporate environmental reporting

Corporate environmental reports (CERs) are only one form of environmental reporting defined as publicly available, stand alone reports, issued voluntarily by the industries on their environmental activities. CER is just a means of environmental improvement and greater accountability, not an end in itself.

Three categories of environmental disclosure are:

- Involuntary Disclosure: Without its permission and against its will (env. Campaign, press *etc.*)
- Mandatory Disclosure: As required by law
- Voluntary Disclosure: The disclosure of information on a voluntary basis

2.4 Objectives of EIA

Objectives of EIA include the following:

- To ensure environmental considerations are explicitly addressed and incorporated into the development decision-making process;
- To anticipate and avoid, minimize or offset the adverse significant biophysical, social and other relevant effects of development proposals;
- To protect the productivity and capacity of natural systems and the ecological processes which maintain their functions; and
- To promote development that is sustainable and optimizes resource use as well as management opportunities

2.5 Types of EIA

Environmental assessments could be classified into four types *i.e.* strategic environmental assessment, regional EIA, sectoral EIA and project level EIA. These are precisely discussed below:

Strategic environmental assessment

Strategic Environmental Assessment (SEA) refers to systematic analysis of the environmental effects of development policies, plans, programmes and other proposed strategic actions. SEA represents a proactive approach to integrate environmental considerations into the higher levels of decision-making – beyond the project level, when major alternatives are still open.

Regional EIA

EIA in the context of regional planning integrates environmental concerns into development planning for a geographic region, normally at the sub-country level. Such an approach is referred to as the economic-cum-environmental (EcE) development planning. This approach facilitates adequate integration of economic development with management of renewable natural resources within the carrying capacity limitation to achieve sustainable development. It fulfils the need for macro-level environmental integration, which the project-oriented EIA is unable to address effectively. Regional EIA addresses the environmental impacts of regional development plans and thus, the context for project-level EIA of the subsequent projects, within the region. In addition, if environmental effects are considered at regional level, then cumulative environmental effects of all the projects within the region can be accounted.

Sectoral EIA

Instead of project-level-EIA, an EIA should take place in the context of regional and sectoral level planning. Once sectoral level development plans have the integrated sectoral environmental concerns addressed, the scope of project-level EIA will be quite minimal. Sectoral EIA helps in addressing specific environmental problems that may be encountered in planning and implementing sectoral development projects.

Project level EIA

Project level EIA refers to the developmental activity in isolation and the impacts that it exerts on the receiving environment. Thus, it may not effectively integrate the cumulative effects of the development in a region.

From the above discussion, it is clear that EIA shall be integrated at all the levels *i.e.* strategic, regional, sectoral and the project level. Whereas, the strategic EIA is a structural change in the way the things are evaluated for decision-making, the regional EIA refers to substantial information processing and drawing complex inferences. The project-level EIA is relatively simple and reaches to meaningful conclusions. Therefore in India, project-level EIA studies take place on a large-scale and are being considered. However, in the re-engineered Notification, provisions have been incorporated for giving a single clearance for the entire industrial estate for *e.g.*, Leather parks, pharma cities, *etc.*, which is a step towards the regional approach.

As we progress and the resource planning concepts emerge in our decision-making process, the integration of overall regional issues will become part of the impact assessment studies.

2.6 Basic EIA Principles

By integrating the environmental impacts of the development activities and their mitigation early in the project planning cycle, the benefits of EIA could be realized in all stages of a project, from exploration and planning, through construction, operations, decommissioning, and beyond site closure.

A properly-conducted-EIA also lessens conflicts by promoting community participation, informing decision makers, and also helps in laying the base for environmentally sound projects. An EIA should meet at least three core values:

- Integrity: The EIA process should be fair, objective, unbiased and balanced
- Utility: The EIA process should provide balanced, credible information for decision-making
- Sustainability: The EIA process should result in environmental safeguards

Ideally an EIA process should be:

- Purposive - should inform decision makers and result in appropriate levels of environmental protection and community well-being.
- Rigorous - should apply 'best practicable' science, employing methodologies and techniques appropriate to address the problems being investigated.
- Practical - should result in providing information and acceptable and implementable solutions for problems faced by proponents.
- Relevant - should provide sufficient, reliable and usable information for development planning and decision making.
- Cost-effective - should impose minimum cost burdens in terms of time and finance on proponents and participants consistent with meeting accepted requirements and objectives of EIA.
- Efficient - should achieve the objectives of EIA within the limits of available information, time, resources and methodology.
- Focused - should concentrate on significant environmental effects and key issues; *i.e.*, the matters that need to be taken into account in making decisions.
- Adaptive - should be adjusted to the realities, issues and circumstances of the proposals under review without compromising the integrity of the process, and be iterative, incorporating lessons learned throughout the project life cycle.
- Participative - should provide appropriate opportunities to inform and involve the interested and affected publics, and their inputs and concerns should be addressed explicitly in the documentation and decision making.
- Inter-disciplinary - should ensure that appropriate techniques and experts in the relevant bio-physical and socio-economic disciplines are employed, including use of traditional knowledge as relevant.

- Credible - should be carried out with professionalism, rigor, fairness, objectivity, impartiality and balance, and be subject to independent checks and verification.
- Integrated - should address the interrelationships of social, economic and biophysical aspects.
- Transparent - should have clear, easily understood requirements for EIA content; ensure public access to information; identify the factors that are to be taken into account in decision making; and acknowledge limitations and difficulties.
- Systematic - should result in full consideration of all relevant information on the affected environment, of proposed alternatives and their impacts, and of the measures necessary to monitor and investigate residual effects.

2.7 Project Cycle

Like any other project, the generic project cycle including that of the Induction and electric arc furnace, submerged arc furnace and cupola of capacity more than 30.000TPA, for which this TGM has been prepared, has six main stages:

1. Project concept
2. Pre-feasibility
3. Feasibility
4. Design and engineering
5. Implementation
6. Monitoring and evaluation

It is important to consider the environmental factors on an equal basis with technical and economic factors throughout the project planning, assessment and implementation phases. Environmental considerations should be introduced at the earliest in the project cycle and must be an integral part of the project pre-feasibility and feasibility stage. If the environmental considerations are given due respect in site selection process by the project proponent, the subsequent stages of the environmental clearance process would get simplified and would also facilitate easy compliance to the mitigation measures throughout the project life cycle.

A project's feasibility study should include a detailed description of significant impacts, and the EIA include a detailed prediction and quantification of impacts and delineation of Environmental Management Plan (EMP). Findings of the EIA study should preferably be incorporated in the project design stage so that the project as well as the site alternatives is studied and necessary changes, if required, are incorporated in the project design stage. This practice will also help the management in assessing the negative impacts and in designing cost-effective remedial measures. In general, EIA enhances the project quality and improves the project planning process.

2.8 Environmental Impacts

Environmental impacts resulting from proposed actions can be grouped into following categories:

- Beneficial or detrimental
- Naturally reversible or irreversible

- Repairable via management practices or irreparable
- Short term or long term
- Temporary or continuous
- Occurring during construction phase or operational phase
- Local, regional, national or global
- Accidental or planned (recognized before hand)
- Direct (primary) or Indirect (secondary)
- Cumulative or single

The category of impact as stated above, and the significance will facilitate the Expert Appraisal Committee (EAC)/State Level EAC (SEAC) to take a look at the ToR for EIA studies, as well as, in decision making process about the developmental activity.

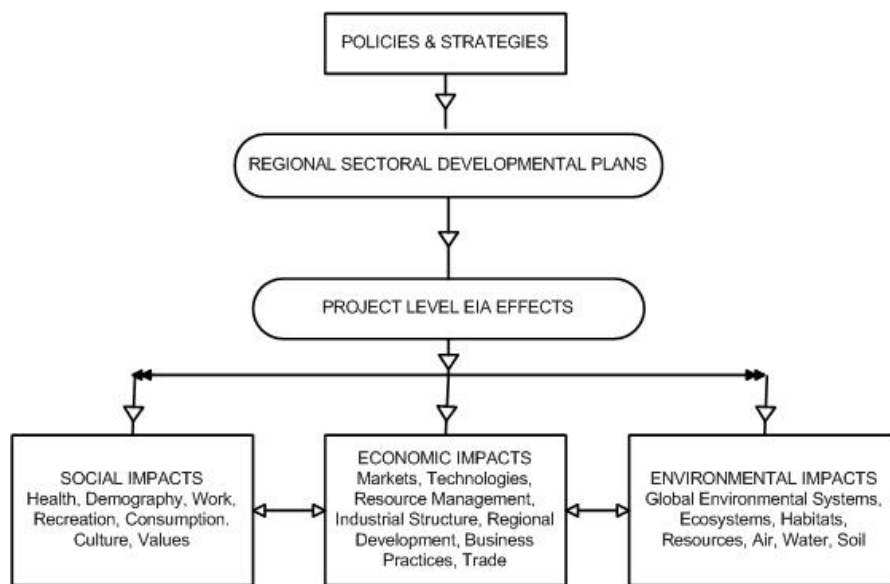

Figure 2-2: Types of Impacts

The nature of impacts could fall within three broad classifications *i.e.*, direct, indirect and cumulative, based on the characteristics of impacts. The assessment of direct, indirect and cumulative impacts should not be considered in isolation or considered as separate stages in the EIA. Ideally, the assessment of such impacts should form an integral part of all stages of the EIA. The TGM does not recommend a single method to assess the types of impacts, but suggests a practical framework/approach that can be adapted and combined to suit a particular project and the nature of impacts.

2.8.1 Direct impacts

Direct impacts occur through direct interaction of an activity with an environmental, social, or economic component. For example, an emission from induction and electric arc furnace, submerged arc furnace and cupola may lead to a decline in air quality.

2.8.2 Indirect impacts

Indirect impacts on the environment are those which are not a direct result of the project, often produced away from or as a result of a complex impact pathway. The indirect impacts are also known as secondary or even tertiary level impacts. For example, ambient air SO₂ rise due to stack emissions may deposit on land as SO₄ and cause acidic

soils. Another example of indirect impact, is the decline in water quality due to accumulation of metals and heavy metals of water bodies receiving contaminated water discharge from the nearby industry. This, in turn, may lead to a secondary indirect impact on aquatic flora in that water body and may further cause reduction in fish population and may also lead to biomagnification. Reduction in fishing harvests, affecting the incomes of fishermen is a third level impact. Such impacts are characterized as socio-economic (third level) impacts. The indirect impacts may also include growth-inducing impacts and other effects related to induced changes to the pattern of land use or additional road network, population density or growth rate. In the process, air, water and other natural systems including the ecosystem may also be affected. Many indirect impacts may also be positive such as greening of the area; improved recreational, health and educational facilities; employment generation and enhanced economic activity of a region.

2.8.3 Cumulative impacts

Cumulative impact consists of an impact that is created as a result of the combination of the project evaluated in the EIA together with other projects in the same vicinity, causing related impacts. These impacts occur when the incremental impact of the project is combined with the cumulative effects of other past, present and reasonably foreseeable future projects. Figure 2-3 depicts the same. Respective EAC may exercise their discretion on a case-by-case basis for considering the cumulative impacts.

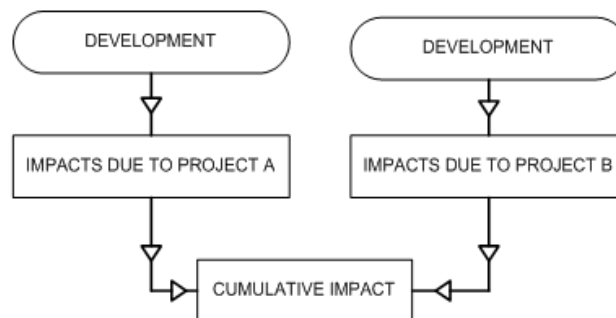

Figure 2-3: Cumulative Impact

2.8.4 Induced impacts

The cumulative impacts can be due to induced actions of projects and activities that may occur if the action under assessment is implemented such as growth-inducing impacts and other effects related to induced changes to the pattern of future land use or additional road network, population density or growth rate (e.g., excess growth may be induced in the zone of influence around an induction and electric arc furnace, submerged arc furnace and cupola project, and in the process causing additional effects on air, water and other natural ecosystems). Induced actions may not be officially announced or be a part of any official announcement/plan. Increase in workforce and nearby communities contributes to this effect.

They usually have no direct relationship with the action under assessment, and represent the growth-inducing potential of an action. New roads leading from those constructed for a project, increased recreational activities (e.g., hunting, fishing), and construction of new service facilities are examples of induced actions.

However, the cumulative impacts due to induced development or third level or even secondary indirect impacts are difficult to be quantified. Because of higher levels of uncertainties, these impacts cannot normally be assessed over a long time horizon. An EIA practitioner usually can only guess as to what such induced impacts may be and the possible extent of their implications on the environmental factors. Respective EAC may exercise their discretion on a case-by-case basis for considering the induced impacts by specifying it very early at TOR stage.

2.9 Significance of Impacts

This TGM establishes the significance of impacts first and proceeds to delineate the associated mitigation measures. So the significance here reflects the “worst-case scenario” before mitigation is applied, and therefore provides an understanding of what may happen if mitigation fails or is not as effective as predicted. For establishing significance of different impacts, understanding the responses and interaction of the environmental system is essential. Hence, the impact interactions and pathways are to be understood and established first. Such an understanding will help in the assessment process to quantify the impact as accurately as possible. Complex interactions, particularly in the case of certain indirect or cumulative impacts, may give rise to non-linear responses which are often difficult to understand and therefore their significance is difficult to assess. It is hence understood that indirect or cumulative impacts are more complex than the direct impacts. Currently the impact assessments are limited to direct impacts. In case mitigation measures are delineated before determining significance of the effect, the significance represents the residual effects.

However, the ultimate objective of an EIA is to achieve sustainable development. The development process shall invariably cause some residual impacts even after implementing an EMP effectively. Environmentalists today are faced with a vital, not-easy-to-answer question—“What is the tolerable level of environmental impact within the sustainable development framework?” As such, it has been recognized that every ecosystem has a threshold for absorbing deterioration and a certain capacity for self-regeneration. These thresholds based on concept of carrying capacity are as follows:

- Waste emissions from a project should be within the assimilative capacity of the local environment to absorb without unacceptable degradation of its future waste absorptive capacity or other important services.
- Harvest rates of renewable resource inputs should be within the regenerative capacity of the natural system that generates them; depletion rates of non-renewable inputs should be equal to the rate at which renewable substitutes are developed by human invention and investment.

The aim of this model is to curb over-consumption and unacceptable environmental degradation. But because of limitation in available scientific basis, this definition provides only general guidelines for determining the sustainable use of inputs and outputs. To establish the level of significance for each identified impact, a three-stage analysis may be referred:

- First, an impact is qualified as being either negative or positive.
- Second, the nature of impacts such as direct, indirect, or cumulative is determined using the impact network
- Third, a scale is used to determine the severity of the effect; for example, an impact is of low, medium, or high significance.

It is not sufficient to simply state the significance of the effect. This determination must be justified, coherent and documented, notably by a determination methodology, which must be described in the methodology section of the report. There are many recognized methodologies to determine the significance of effects.

2.9.1 Criteria/methodology to determine the significance of the identified impacts

The criteria can be determined by answering some questions regarding the factors affecting the significance. This will help the EIA stake-holders, the practitioner in particular, to determine the significance of the identified impacts eventually. Typical examples of such factors include the following:

- Exceeding of threshold limit: Significance may increase if a threshold is exceeded. *e.g.*, particulate matter emissions exceed the permissible threshold.
- Effectiveness of mitigation: Significance may increase as the effectiveness of mitigation measures decreases. *e.g.*, control technologies, which may not assure consistent compliance to the requirements.
- Size of study area: Significance may increase as the zone of effects increases.
- Incremental contribution of effects from action under review: Significance may increase as the relative contribution of an action increases.
- Relative contribution of effects of other actions: Significance may decrease as the significance of nearby larger actions increase.
- Relative rarity of species: Significance may increase as species becomes increasingly rare or threatened.
- Significance of local effects: Significance may increase as the significance of local effects is high.
- Magnitude of change relative to natural background variability: Significance may decrease if effects are within natural assimilative capacity or variability.
- Creation of induced actions: Significance may increase as an induced activity also becomes highly significant.
- Degree of existing disturbance: Significance may increase if the surrounding environment is pristine.

For determining significance of impacts, it is important to remember that secondary and higher order effects can also occur as a result of a primary interaction between a project activity and the local environment. Wherever a primary effect is identified, the practitioner should always think if secondary or tertiary effects on other aspects of the environment could also arise.

The EIA should also consider the effects that could arise from the project due to induced developments, which take place as a consequence of the project. *e.g.*, Population density and associated infrastructure and jobs for people attracted to the area by the project. It also requires consideration of cumulative effects that could arise from a combination of the effects due to other projects with those of other existing or planned developments in the surrounding area. So the necessity to formulate a qualitative checklist is suggested to test significance, in general.

3.

ABOUT INDUCTION/ELECTRIC ARC/CUPOLA FURNACES INCLUDING BEST PRACTICES AND POLLUTION CONTROL TECHNOLOGIES

Induction Furnaces (IF) are found both in secondary steel and secondary non-ferrous industries, whereas, most common use of Electric Arc Furnace (EAF)/Submerged Arc Furnace is found in the secondary steel industry. For many years, the cupola was the primary method of melting used in iron foundries, however, in recent times, the use of the cupola has declined in favour of electric/induction melting, which offers more precise control of melt chemistry & temperature, and also releases much lower levels of emissions. Among this group, the cupola is the furnace type that uses coke as a fuel; combustion air used to burn the coke is introduced through tuyeres located at the base of the cupola. The others use electricity for melting.

The growth in the production of the secondary steel sector has been quite significant, specially in the post liberalization / de-regulation period so much so that they have become the driver of growth in many areas. Steel manufacturing through EAFs has matured in India as an industry. From a mere 9 per cent (%) of steel production in the country in 1956, EAFs today account for 27.4% of the steel production. Engaged primarily in stainless steel production with imported technology, the induction furnace segment was marked by two changes that spurred growth; (i) development of indigenous technology and (ii) use of sponge iron which revolutionized mild steel making in induction furnace. The share of induction furnaces in total crude steel production is increasing fast and today it is 31.5%. Table 3-1 captures such aspects:

Table 3-1: Approximate Share of EAF & Induction Furnace (%) in total Crude Steel Production (in thousand tonnes)

Unit	2005-06	2006-07	2007-08*
EAF	11,273 (27%)	13,250 (26%)	14,800 (27.4%)
IF	8,693 (21%)	15,390 (30%)	17,000 (31.5%)
Total Crude Steel	41,660	50,817	53,904

*Source: JPC Bulletin on Iron & Steel, March 2007 Vol. VII, Issue 3 & June 2008, Volume VIII, Issue 6, * Prov.*

In foundry industry, various types of castings produced are made of ferrous, non-ferrous, aluminum alloy, graded cast iron, ductile iron, steel, etc., for application in automobiles, railways, pumps, compressors, valves, diesel engines, cement/electrical/textile machinery, aero & sanitary pipes, pipe fittings, castings for special applications, etc. However, grey iron castings have the major share, i.e., about 70 % of total castings produced. Most foundries use cupolas using coke.

There are about 4500 foundry units in the country, of which 80% can be classified as small-scale units and 10% each as medium & large scale units. About 500 units have International Quality Accreditation. The large foundries are modern, globally

Induction/Electric Arc/Cupola Furnaces Industry

competitive and are working at nearly full capacity. There is growing awareness about environment, thus many foundries are switching over to induction furnaces while some units in Agra are shifting to cokeless cupolas.

The exports showed healthy trends - approx 25-30% years on year (YOY). The exports for FY 2005-06 were about USD 800 Million.

The industry directly employs about 5,00,000 people and indirectly about 1,50,000 people. It is labour-intensive industry. The small units are mainly dependant on manual labour. However, the medium & large units are semi/ largely mechanized. Despite being the most important industry in the small-scale sector, these foundries are often with low-levels of mechanization, primarily family-owned and managed with typical capacity of about 3 million tonnes of castings per annum.

Grey iron is the major component of production followed by steel, ductile iron & non ferrous as shown in the figure below:

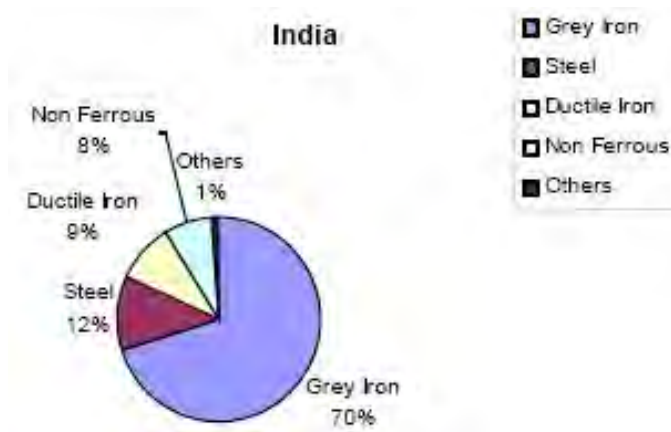

Figure 3-1: Composition of Metal Production in India

3.1 History and Development of Induction, Electric Arc, Submerged Arc and Cupola Furnace Industry

3.1.1 Induction furnace industry

Medium frequency induction furnaces have been used in India to produce crude steel for the last 25 years. It was only with de-regulation that the induction furnace industry in India emerged in big form. With a host of units producing mild steel ingots (apart from castings) in different pockets in the country, but more concentrated in the northern belt, the Induction Furnaces came up to cater to domestic demand, which could not be adequately met by the large scale integrated steel plants. While furnace of bigger size and capacity were observed, there was also the large scale acceptance and adoption of sponge iron in the charge mix. It may be seen that Induction Furnaces have started producing steel even in those states where crude steel is being supplied by integrated steel plants. The size of the Induction Furnaces used in making the crude steel is 5, 8,10 and 15 tonne per charge. The old system of using 3 tonne per charge furnaces has now become obsolete.

The induction furnace industry prospered in the immediate post de-regulation period, but fell victim to the slow down phase of the late 90's. This phase saw quite a bit of

structural changes in the industry in the form of closure and consolidation. Over the time, induction furnace route has emerged as a key driver of crude steel production in the country with a rising share in total production as already mentioned above. As it is expected that demand of steel in India will start rising very fast to narrow the gap of per capita steel consumption with developed countries, the demand of induction furnace steel may increase further.

3.1.2 EAF industry

In India, very high investment costs and terminal time overruns in commissioning of the greenfield integrated steel plants using the blast furnace – basic oxygen furnace route of steel production, coupled with the worrisome shortage of good quality metallurgical coke, has resulted in adoption of EAF. APP countries produce 46% of all EAF steel produced globally. Table 3-2 compares the production of EAF steel in 2005 in India, the APP countries and worldwide.

Table 3-2: Production of EAF Steel

Country	Production (million tonnes)
Australia	1.4
China	45.1
India	17.1
Japan	28.8
South Korea	21.1
USA	52.2
APP Total	165.6
Worldwide	358.1

Current ongoing EAF steelmaking research includes reducing electricity requirement per tonne of steel, modifying equipment and practices to minimize consumption of the graphite electrodes, and improving the quality and range of steel produced from low quality scrap.

Over the years, enough improvements have taken place in the design and operational features of EAFs that have contributed to significant cost savings and increase in productivity. Some of the innovations that have taken place with reference to EAFs can be classified into three segments, *i.e.*:

- Pre-smelting technology: Scrap preheating, dezincing of scrap;
- Smelting technology: Use of UHP technology, introduction of water cooled panels in furnace wall and roof, effective fume extraction, high amount of automation and computerization in both design and operation,
- Post smelting technology: Use of ladle refinement of steel

The EAF steelmaking has been commercially established for various types of charge materials. The various types of charge materials and their extent of usage in EAF are shown in Table 3-3.

Table 3-3: Types of Charge Mix and their Usage in EAF Steelmaking

S. No.	Type of Charge Mix	Extent of Usage (%)
1	Steel scrap	0 – 100
2	Solid pig iron	0 – 50
3	Liquid Hot Metal	0 – 70
4	HBI / DRI	0 – 100
5	Iron Carbide	0 - 50

The general trend in EAF steelmaking is to use either 100% steel scrap or a mixture of steel scrap, HBI/DRI, liquid/solid pig iron in different proportion. Selection of charge mix depends upon availability of charge materials and quality of steel with respect to acceptable tramp materials. As some of the tramp materials can not be easily removed during steel making. Only way to minimize content of such elements is through dilution. DRI / HBI, iron carbide, liquid hot metal, *etc.* are some of the materials, which could be used as dilutants.

The EAFs are also used for production of ferroalloys and other non-ferrous alloys, and for production of phosphorus. Furnaces for these services are physically different from steel-making furnaces and may operate on a continuous, rather than batch, basis. Continuous process furnaces may also use paste-type (Soderberg) electrodes to prevent interruptions due to electrode changes. Such furnaces are usually known as submerged arc furnaces, because the electrode tips are buried in the slag/charge, and arcing occurs through the slag, between the matte and the electrode. A steelmaking arc furnace, by comparison, arcs in the open. The key is the electrical resistance, which generates the heat required. The resistance in steelmaking furnace is the atmosphere, while in a submerged arc furnace, it is slag or charge. The liquid metal formed in either furnace is too conductive to form an effective heat-generating resistance.

3.1.3 Cupola furnace

India is fast emerging as an important global player in the casting sector of metallurgical industry. Most foundries use cupolas using metallurgical coke. This is mainly due to the stringent pollution control standards in the developed countries and the exponential growth in automobile and machine tool sectors within the country. There is also a growing awareness regarding pollution control levels in India in recent times and this is perceived as a threat to the existence of these small-scale foundry units scattered in various parts of the country unless best practicable means are implemented.

Foundry industry in India is well established. According to the recent World Census of Castings by Modern Castings, USA, India ranks as number six country in the world producing an estimated 6 MT of various grades of castings as per the International Standards.

There are several foundry clusters. Each cluster is known for its type of products. Some of the major clusters are Batala, Jalandhar, Ludhiana, Belgaum, Chennai, Kolhapur, Rajkot, Coimbatore, Howrah, Agra, Pune and Rajkot.

3.2 Scientific Aspects of Industrial Processes

3.2.1 Electric steel making

All metal melting electric furnaces can be divided into three groups according to the methods by which electric energy is transferred into heat.

- **Induction Furnaces:** In these furnaces, electromagnetic induction is used to heat the metal. An alternating current supplied to a primary coil (inductor) sets up a variable magnetic field around that coil. The variable magnetic flux in turn induces an electromotive force in the secondary circuit (metallic charge), so that the metal is melted by the alternating current formed in it.
- **EAF:** In furnaces of this type, the electric energy is used to form an electric arc which heats the metal by radiant heat evolved. This can be further sub-divided as:
 - **Direct Arc Furnace:** Electric arcs are formed between the electrodes and metal being heated, which is thus a component of the electric circuit and is heated by radiation from the arcs. They are used in steel making.
 - **Submerged Arc Furnace:** The arcs burn under a cover of solid charge which surrounds the electrodes. These are mostly used for ore smelting operations, in particular for making ferro-alloys.
 - **Plasma Furnaces:** The heat is evolved by a flow of pressurized ionized gas supplied into the arc discharge zone. Plasma furnaces can produce very high temperatures, up to 2000 °C. They are used for melting special steels, alloys and pure metals.
- **Resistance furnaces:** In these furnaces, the heat is generated by special heating elements and is transferred to the body to be heated by radiation and convection. The body, which has a high electric resistivity, is heated directly by passing electric current through it.

The EAF and induction furnaces are more commonly used in India for metal smelting.

3.2.1.1 Induction furnace

The application of induction heating for melting steels was first attempted at the beginning of the 20th Century. Since then, induction heating has found very wide applications in melting ferrous and non-ferrous metals, case hardening of parts and heating of blanks before forging and stamping.

Induction melting process is being used for manufacturing aluminum, zinc, copper and their alloys; cast iron of all types; carbon steel, and low alloy as well as high alloy steels.

From the standpoint of thermal engineering, an induction furnace is a merely perfect plant, since the heat is generated in the place where it is to be consumed.

Induction furnaces may be with or without iron core. The first iron core induction furnace for melting steel was built by Kjellin of Sweden in 1901. In 1916, Northrup of the USA put a coreless induction furnace into industrial application.

A. Iron-core induction furnace

Two main types of iron-core furnaces exist: (i) furnace with an open horizontal channel and (ii) those with closed horizontal or vertical channel.

In the first type, metal is melted by an electric current induced in the metallic charge hopper; in those with a closed channel, electric energy is induced in a narrow channel filled with molten metal, while the solid charge in the furnace shaft is heated by the overheated metal that circulates in the channel. This is shown in Figure 3-2.

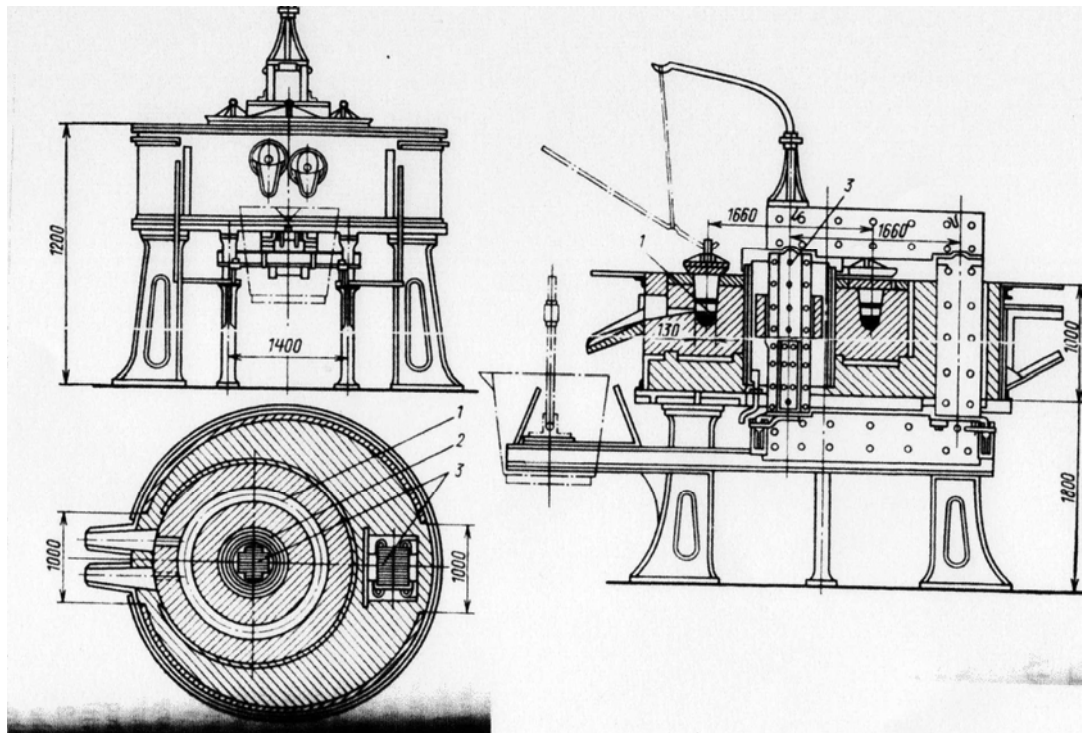

Figure 3-2: Open Top Iron Core Induction Furnace

Note: 1. Channel with molten metal, 2. Inductor, 3. Core

Furnaces with an open annular channel could not compete with other types of melting plants due to some limitations.

B. Closed channel furnaces

Closed channel induction furnaces with an iron core have found wide applications for remelting non-ferrous metals and as mixers to heat conversion iron in foundry shops. As shown in Figure 3-3, a closed channel furnace comprises a cylindrical shaft (1), made of sheet iron and lined with refractory materials, and a bottom block (2) which is enclosed in a detachable cast shell (3). An inductor (4) is placed into the central portion of the iron core in hole provided in the bottom block. The metal that fills a narrow channel in the bottom block is heated by the induced current. After being placed into the shaft, the charge is melted owing to the intensive circulation of molten metal. The oxidation loss of non-ferrous metal during melting is not high, as the metal is being superheated in the closed channel, its vapours condense on the colder metal of the shaft.

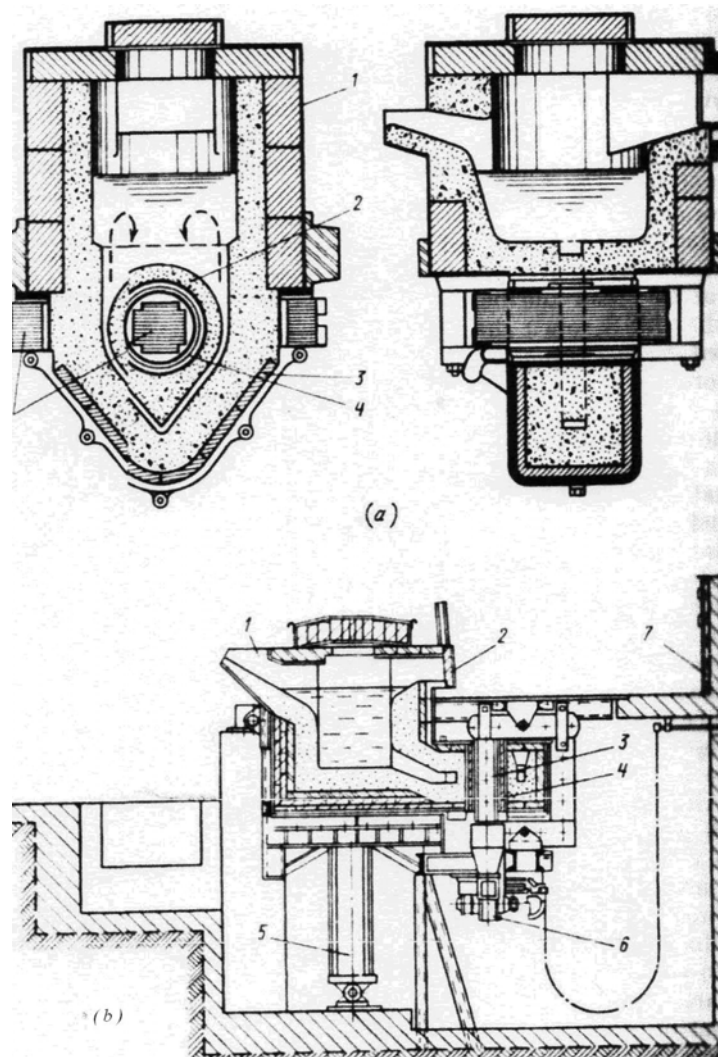

Figure 3-3: Closed Channel Iron Core Induction Furnace

Note:

(a). Furnace with vertical closed channel; 1. Shaft, 2. Bottom block, 3. Builtup shell, 4. Inductor, 5. Core

(b). Furnace with horizontal closed channel, 1. Furnace, 2. Charging door, 3. Core, 4. Inductor, 5. Hydraulic tilting mechanism, 6. Ventilators, 7. Control board, 8. Contactors

Among the drawbacks of the closed channel furnaces are the relatively cold slag, the necessity to leave around 20% of the mass of the previous charge as ‘heel’ in the furnace and low durability of the bottom block when melting high melting temperature metals.

C. Coreless induction furnace

Ferrous metallurgy mostly uses core-less (or high frequency) induction furnace. The assembly of this type consists of a crucible within a water-cooled copper coil and a framework on which the supports are arranged for tilting during pouring. The primary circuit is formed by the coil, and the secondary circuit is the crucible or, rather, the charge in it. The lines of magnetic force link through the charge and induce eddy current in it,

and the later generates heat. The magnetic field and electro-dynamic forces acting in the crucible of an induction furnace and the electro-dynamic circulation of metal in the crucible of an induction furnace is shown in Figure 3-4.

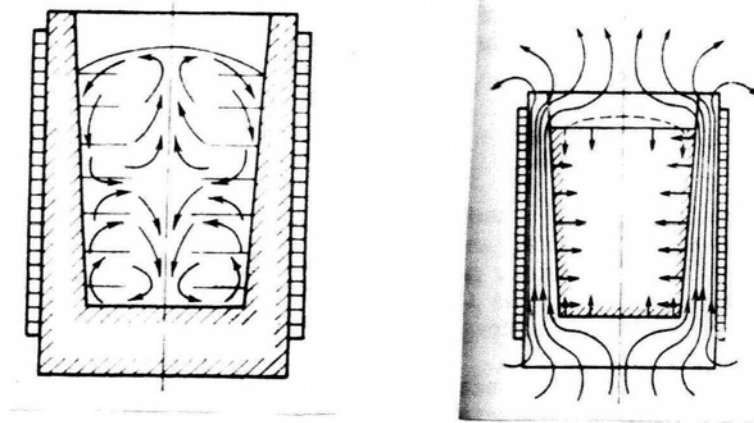

Figure 3-4: Magnetic Field and Electro-dynamic Forces acting in the Crucible of an Induction Furnace and Electro-dynamic Circulation of Metal in the Crucible of an Induction Furnace

The electromotive force of induction E (in V) is:

$$E = 4.44\phi_{\max} fn10^{-8}$$

Where,

n = number of the inductor turns

ϕ_{\max} = magnetic flux density

f = alternating current frequency, Hz

If ϕ_{\max} drops, the required electromotive force of induction can be maintained by increasing the current frequency. Based on frequency of current supplied, the induction furnaces can be classified into three types:

High frequency	200 to 1000 kHz, operating with valve generators. These are mostly used for making high alloy steels or refractory metals and alloys
Medium frequency	500 to 10,000 Hz, supplied with rotary or thyristor converters. These are used for all types of steel melting
Low frequency	50 Hz, which are fed directly from mains. These are used for non-ferrous as well as cast iron including malleable and spheroidal graphite iron.

The density of induced currents attains its maximum at the surface of the charge and lowers towards the middle. The depth of the surface layer of a metal (charge) where the density of induced current is large is called penetration depth. The heat required to melt the charge is developed mainly in that layer.

The penetration depth Δe (in cm) can be calculated using the formula:

$$\Delta_e = 5.03 \times 10^3 \sqrt{\rho/\mu f}$$

Where,

ρ = resistivity of the charge, ohm.cm

μ = magnetic permeability, and

f = frequency, Hz

For iron at 20⁰C, $\rho = 10^{-5}$ ohm.cm and $\mu = 100$; but the moment iron loses its magnetic properties (around 750⁰C), $\rho = 1.1 \times 10^{-4}$ ohm.cm and $\mu = 1.0$.

The lowest frequency for a given metal at its Curie point is determined by the formula:

$$f_{\min} \geq 2.5 \times 10^9 (\rho/d^2)$$

where,

d = mean diameter of the crucible in cm

This means large furnaces require lower frequency than smaller ones.

The energy W (in W) that is transformed into heat in the charge is given by formula:

$$W = I^2 n^2 2\pi^2 (d/h) \sqrt{\rho \mu f} \cdot 10^{-9}$$

Where,

I = current in the inductor, A

h = depth of metal in the crucible, cm

The product (In) is called ampere-turns. The energy that is transformed into heat in the charge is directly proportional to the square of ampere-turns and the square root of resistivity and frequency.

Coreless induction furnaces possess certain advantages over EAFs as listed below:

- since there are no electrodes, it is possible to melt steels very low in carbon
- the absence of arcs ensures that the metal is very low in gasses
- alloying additions are oxidized only insignificantly and the furnace productivity is high
- temperature of the process can be controlled quite accurately

However, there are limitations of coreless induction furnaces for melting steel as the slag is heated only by the bath, and this may not be enough for it to melt. For this reason, slag assisted refining is out of question and the melting of charges of clean metals and alloys of known analysis is the principle field of the coreless induction furnaces. Thus, slag inclusion in the bath does not pose much problem. This also helps to keep the environment clean. Limited oxidation, high temperature, intimate stirring, and no electrodes to carburise the melt all serve to produce alloy steels and composite alloys

extremely low in carbon. In case carbon in bath is high, sponge iron is added to reduce it. It will also reduce sulphur and phosphorus content.

D. Induction Furnace Process

In a typical ferrous smelting case, the materials used for melting in induction furnaces consists of the elements as mentioned in Table 3-4 below:

Table 3-4: Typical Composition of Input Materials for Induction Furnace

Composition (%)	Min.	Max.
Steel Scrap		
Carbon (C)	0.15	0.30
Manganese (Mn)	0.60	1.00
Silicon (Si)	0.15	0.35
Phosphorus (P)	0.04	0.06
Sulphur (S)	0.04	0.06
Sponge Iron		
Carbon (C)	0.05	0.20
Fe (total)	90.00	92.00
Gangue or non-metallics	Balance	
Hot Briquetted Iron (HBI)		
Carbon (C)	0.7	1.2
FeO	6.00	8.00
Fe (metallics)	90.00	92.00
Non-metallics	Balance	
Cast Iron Scrap		
Carbon (C)	3.30	4.0
Phosphorous (P)	0.1	0.45
Sulphur (S)	0.15	0.25
Manganese (Mn)	0.70	0.85
Silicon (Si)	1.50	2.8

First, cast iron scrap of above chemical composition is melted in the furnace. The quantity of cast iron scrap is only 5%. This is done to make a pool of liquid metal to enable steel scrap to melt faster in the furnace. The steel scrap charged is having carbon content within specification limit of mild steel. Small quantity of lime is used to flux out the oxidized elements which form slag. The slag formed is maximum 2% of charge. No oxygen lancing is done. The following reactions occur:

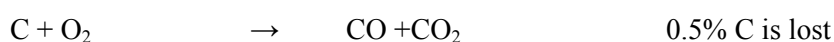
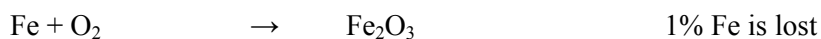

Induction/Electric Arc/Cupola Furnaces Industry

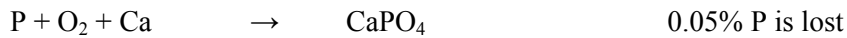

The molten metal will, therefore, have the chemical composition having all elements as per specification because the presence of cast iron scrap in small quantity does not influence in increase of any element.

Sponge iron addition is done along with charge up to a maximum of 40% depending on the bath chemistry. Sponge iron has carbon less than 0.2%, which in fact dilutes excess carbon in steel scrap. If HBI is used, it is a great advantage in reducing carbon content of bath. FeO present in HBI reduces the carbon content.

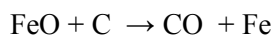

If carbon in bath is in excess of 0.3%, more HBI is used. Thus refining is carried out. Ferroalloys are added to molten metal but this addition does not lead to any air pollution as the alloys dissolve in molten metal.

3.2.1.2 Electric arc steel-making furnaces

Heroult of France has now become almost universal. An EAF is a furnace that heats charged material by means of an electric arc. They range in size from small units of approximately one tonne capacity (used in foundries for producing cast iron products) up to about 400 tonne units used for secondary steelmaking. Arc furnaces used in research laboratories and by dentists may have a capacity of only a few dozen grams. EAF temperatures can be up to 1,800 °C. Figure 3-5 shows a modern EAF.

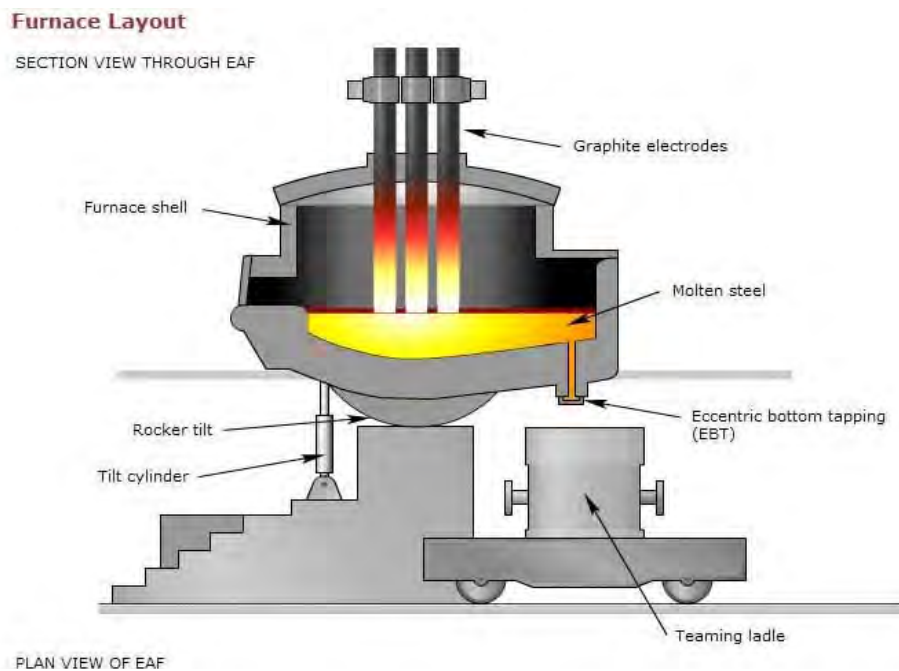

Figure 3-5: A Modern EAF

The furnace has a steel shell in the form of a tapered cylinder with a spherical bottom. The shell has a refractory lining inside. The reaction chamber of the furnace is covered from above by a removable roof made of refractory bricks held by a roof ring. The furnace has a main charging door and a tap hole with tapping spout. It is fed with a three phase alternating current and has three electrodes fastened in electrode clamps which are connected by means of a sleeve with a movable electrode stand. Current is supplied via water cooled flexible cables and water cooled copper tubes. The furnace rests upon two support sectors which can roll on the furnace stand to tilt the furnace towards the main door and towards the tap hole for tapping, the tilting motion being affected by a rack mechanism.

The furnace is charged from the top by means of a pan. To open the reaction chamber for charging, the furnace roof which is suspended from chains is raised up to the gantry. The latter together with the roof and electrodes, can be swung towards the tapping spout. A rotating mechanism is provided to rotate the furnace shell through an angle of 40 degrees in both directions from the normal position. The furnace also has an electromagnetic stirring device for intermixing of molten metal.

Although electricity provides most of the energy for EAF steelmaking, supplemental heating from oxy-fuel and oxygen injection is used. The major advantage of EAF steelmaking is that it does not require molten iron supply. By eliminating the need for blast furnaces and associated plant processes like coke oven batteries, EAF technology has facilitated the proliferation of mini-mills, which can operate economically at a smaller scale than larger integrated steelmaking. EAF steelmaking can use a wide range of scrap types, as well as DRI and molten iron (up to 70%). This recycling saves virgin raw materials and the energy required for converting them. The EAF operates as a batch melting process, producing heats of molten steel with tap-to- tap times for modern furnaces of less than 60 minutes.

Arc furnace process

Steel in arc furnace may be refined with or without oxidation. Oxidation may be dispensed where the metal ingredients of the charge are close to the desired steel grade in analysis. In such case, a reducing slag is used both in melting and refining (single refining or single slag practice). Usually, this process is used to smelt alloy wastes to alloy steel. In working with oxidation, the charge is melted and refined under an oxidizing slag or 'black slag' (the slag is called 'black' due to the colour it is given by the iron oxide), removing phosphorous and/or carbon almost completely; then the 'black slag' is removed and a reducing or 'white slag' containing lime, fluorspar, silica, carbon and/or ferrosilicon made up, giving a very high degree of desulphurisation and good deoxidation. Additions of the required ferroalloys are made during this stage, or sometimes to the ladle.

The principal processes in the oxidizing period are (i) removal of phosphorous, (ii) oxidation of silicon and manganese, (iii) removal of sulphur, (iv) removal of nitrogen and hydrogen, (v) removal of non-metallic inclusions, (vi) heating of the metal, (vii) reboil, and (viii) carbonization of metal. A modern development in arc furnace practice is the use of an oxygen lance for injecting high pressure oxygen into the bath, during the oxidation period. This removes carbon more rapidly than by ore alone. Lancing does not need an arc for heating. The use of oxygen lance has special advantage in the manufacture of stainless steel. If oxygen is blown into the metal, exothermic reactions prevail in the bath, the metal is heated up quickly, and it is possible to switch off the current as soon as the carbon begins to burn intensively.

The aims of the reducing period during the melt in a basic EAF are (i) deoxidation of the metal, (ii) removal of sulphur, (iii) adjustment of the steel composition to specifications, (iv) control of the bath temperature, and (v) preparation of well oxidized free running highly basic slag, which can be used for of-furnace treatment of the metal in the ladle. The reducing period can be shortened considerably if the metal is treated with argon or synthetic slag or deoxidized in the ladle.

3.2.2 Non electric steel making

3.2.2.1 Cupola furnace

The use of cupola furnaces is one of the oldest processes for making cast iron and is still among the dominant technologies in the world.

The construction of a conventional cupola consists of a vertical steel shell which is lined with a refractory brick. The charge is introduced into the furnace body by means of an opening approximately half way up the vertical shaft. The charge consists of alternate layers of the metal to be melted, coke fuel and limestone flux. The fuel is burnt in air which is introduced through tuyeres positioned above the hearth. The hot gases generated in the lower part of the shaft ascend and preheat the descending charge.

Most cupolas are of the drop bottom type with hinged doors under the hearth, which allows the bottom to drop away at the end of melting to aid cleaning and repairs. At the bottom front is a taphole for the molten iron; at the rear, positioned above the taphole is a slaghole. The top of the stack is capped with a spark/fume arrester hood.

Typical internal diameters of cupolas are 450 mm to 2000 mm diameter which can be operated on different fuel to metal ratios, giving melt rates of approximately 1-30 tonnes per hour.

A typical cupola furnace is shown in Figure 3-6.

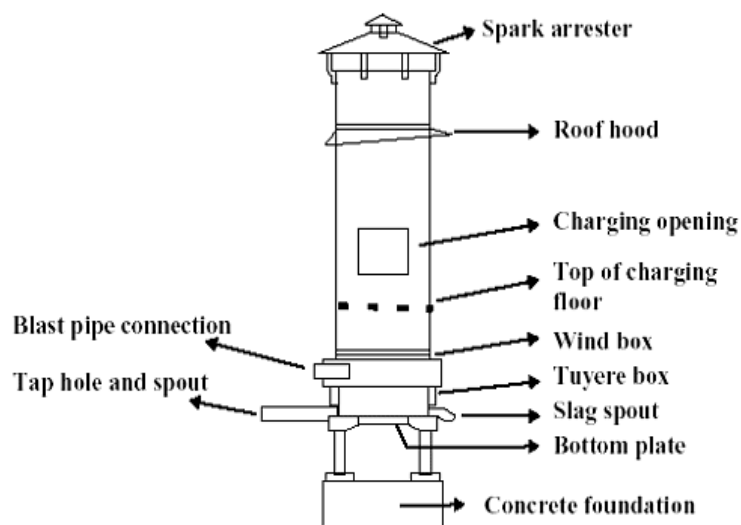

Figure 3-6: Typical Cupola Furnace

A typical operation cycle for a cupola would consist of closing and propping the bottom hinged doors and preparing a hearth bottom. The bottom is usually made from low strength moulding sand and slopes towards a tapping hole. A fire is started in the hearth using light weight timber, coke is charged on top of the fire and is burnt by increasing the air draught from the tuyeres. Once the coke bed is ignited and of the required height, alternate layers of metal, flux and coke are added until the level reaches the charged doors. The metal charge would typically consist of pig iron, scrap steel and domestic returns.

Once the furnace is sufficiently filled with fuel and crude material, air is blasted into the combustion mixture, increasing the temperature inside the furnace. Some furnaces have special devices that insert pure oxygen gas into the furnace's interior. When burned in the presence of oxygen, the high-carbon coke fuel undergoes a chemical reaction to produce the gases carbon monoxide and dioxide, which diffuse through nearby molten metal and increase its carbon levels. An air blast is introduced through the wind box and tuyeres located near the bottom of the cupola. The air reacts chemically with the carbonaceous fuel thus producing heat of combustion.

Soon after the blast is turned on, molten metal collects on the hearth bottom where it is eventually tapped out into a waiting ladle or receiver. As the metal is melted and fuel consumed, additional charges are added to maintain a level at the charging door and provide a continuous supply of molten iron.

At the end of the melting campaign, charging is stopped but the air blast is maintained until all of the metal is melted and tapped off. The air is then turned off and the bottom doors opened allowing the residual charge material to be dumped.

The process can be briefly described as follows:

- The charge, consisting of metal, alloying ingredients, limestone, and coal coke for fuel and carbonisation (8-16% of the metal charge), is fed in alternating layers through an opening in the cylinder.
- Air enters the bottom through tuyeres extending a short distance into the interior of the cylinder. The air inflow often contains enhanced oxygen levels.
- Coke is consumed. The hot exhaust gases rise up through the charge, preheating it. This increases the energy efficiency of the furnace. The charge drops and is melted.
- Although air is fed into the furnace, the environment is a reducing one. Burning of coke under reducing conditions raises the carbon content of the metal charge to the casting specifications.
- As the material is consumed, additional charges can be added to the furnace.
- A continuous flow of iron emerges from the bottom of the furnace.
- Depending on the size of the furnace, the flow rate can be as high as 100 tonnes per hour. At the metal melts it is refined to some extent, which removes contaminants. This makes this process more suitable than electric furnaces for dirty charges.
- A hole higher than the tap allows slag to be drawn off.
- The exhaust gases emerge from the top of the cupola. Emission control technology is used to treat the emissions to meet environmental standards.
- Hinged doors at the bottom allow the furnace to be emptied when not in use.

3.2.3 Manufacturing process in the context of environmental pollution

3.2.3.1 Induction furnace

Only air pollution occurs and no water or noise pollution takes place in induction furnace. The scrap charge when melted emits metallurgical smoke due to oxidation having solid particles as well as gaseous pollutants. The steel melting scrap charge may have dust and rust which on heating disintegrates from metal. Some refractory lining may also contribute to the solid pollutants. Thus the solid pollutants will consist of suspended particulate matters of iron oxide, alumina, silica, magnesia, calcium oxide and alkali oxides. The gaseous pollutants will consist of CO, CO₂, HC, and small proportion of SO₂. In case scrap consists of galvanized parts, small percentage of volatilized zinc can be found in gases.

3.2.3.2 Electric arc furnace

EAF exerts air emissions, wastewater and solid waste which lead to impacts on air, water and land.

Steel can be produced from scrap steel in an EAF in which the scrap is melted. The scrap is usually preheated in a specific furnace and loaded together with lime or dolomite, which are used as flux for slag formation. It is normal to charge about 50-60 % of the scrap initially. The electrodes are then lowered to the scrap. Within 20-30 mm above the scrap they strike an arc. After the first charge has been melted, the remainder of the scrap is added. During the initial period of melting, the applied power is kept low to prevent damage to the furnace walls and roof from radiation, while allowing the electrodes to bore into the scrap. As soon as the arcs have become shielded by the surrounding scrap, the power is increased to complete melting. Oxygen lances and/or oxy-fuel burners are frequently used to assist in the early stages of melting. Oxygen may be added to the liquid steel by specific nozzles in the bottom or side wall of the EAF. Fuels include natural gas and oil. Sponge iron can replace scrap to a considerable extent. Hot metal in proportion of maximum 70% can also be added.

A. Gas cleaning

Modern large steel making arc furnaces eject a large amount of dust laden gases into the atmosphere. The use of oxygen and powdered materials aggravates the problem. The content of dust in the gaseous emissions may vary between 1 to 10 g/m³ in various periods of furnace operation – much exceeding the emission norms. Therefore the problem of dust collection and cleaning is quite critical.

EAFs generate particulate matter during melting; oxygen injection and decarbonizing phases (primary off-gas emissions); and charging / tapping (secondary off-gas emissions). The primary emissions contain considerable carbon monoxide (CO) along with dust. Sources of CO include waste gases from the EAF. CO is generated from the oxidation of coke in smelting and reduction processes, and from the oxidation of the graphite electrodes and the carbon from the metal bath during melting and refining phases in EAFs.

The most effective system of primary gas removal is individual gas removal via the roof aperture. The gases are exhausted by forming a negative pressure within a range of 1.25

to 2.5 mm H₂O. To prevent the possible explosion of CO, which evolves from the furnace during the oxidation period, the system is provided with a means to suck in excess air from a gap in the ducting system, generally at elbow. This mixes with furnace gases and ensures complete combustion in the gas cleaning system. The primary emissions are collected from EAF casing by water cooled ducts, excess CO burnt, gases cooled and discharged to atmosphere after cleaning in a fabric filter or any suitable dust collection system.

The volume of primary gas generation depends upon the decarburization rate of the charge. In case, a reasonable EAF size is limited to approximately 150 t (specially DC type), a tap-to-tap time of 1 hr. or less has to be maintained. This leads to the consequence that the power on/oxygen on time must not exceed a maximum of 45 min., and the available time for decarburization is approx. 40 min. If a charge mixture to be refined during this time period, consisting approximately 50% hot metal, 35% sponge iron, 10% revert scrap and 5% pool iron (*i.e.*, cold pig iron), a decarburization rate of about 0.1% C/min is to be achieved in place of 0.05% C/min. in conventional refining. For example, in EAF of 130 t capacity and decarburization rate of 0.1% C/min, oxygen blowing rate of 6000 Nm³/h. is required to convert C to CO. The calculated quantity of primary gas works out to about 31,600 Nm³/h at a gas temperature of about 1700°C. Further, for complete combustion of CO to CO₂, another 80,000 Nm³/h of atmospheric air at 40 °C is needed which also cools the gases before entering water cooled duct, and cooled gases of amount 111,600 N m³/h at 600°C is generated. This may need further cooling before entering gas cooler, thus may require air dilution.

The fugitive emissions from secondary off-gas emissions *i.e.*, scrap charging, oxygen blowing, tapping, hot metal transfer, and slag handling are usually collected by local hooding and de-dusted in the same fabric filters after a mixing chamber. Also, at mixing chamber, provision for emergency cooling is to be kept to protect the fabric filters.

For a 130 t EAF, the fugitive emission during charging the EAF with roof removed is about 880,000 Nm³/h. Figure 3-7 indicates a system of connecting 2 EAFs in a single gas cleaning system for optimization. EAF 1 is charging and maximum fugitive emission of 880,000 Nm³/h at 65°C is sucked through canopy. EAF 2 is melting with primary suction of 31,600 Nm³/h at 1700°C; dilution air of 80,000 Nm³/h at 50°C for complete combustion of CO to CO₂; and further dilution air of 30,000 Nm³/h at 50 °C reducing temperature further. The canopy over EAF 2 also sucks 670,000 Nm³/h at 50 °C to control fugitive emission from leakages. The volume controls are done through auto dampers to regulate flow. The mixed air goes to a gas cooler and then to a fabric filter and fan before discharging to atmosphere. Many such combinations can be made judiciously (like both EAFs melting/one melting – one charging) to optimize gas cleaning plant capacity in case there are more than one EAFs in a single melt shop.

Induction/Electric Arc/Cupola Furnaces Industry

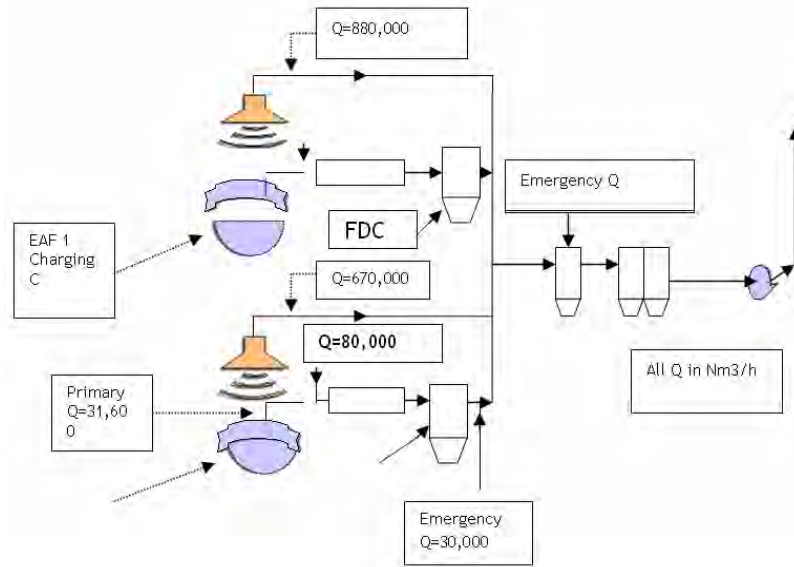

Figure 3-7: Two EAFs connected – A Typical Case

Design of canopy for control of fugitive emission is of utmost importance. The size of canopy can be found out from Figure. 3-8 and the following formula:

$$H = 0.437 C^{0.88}; \quad A = 2.58 W^{1.138};$$

Where,

H = Hood dia (m); W = Furnace dia (m);

P = Theoretical point; Hood face velocity = 0.5 – 1.0 m/s;

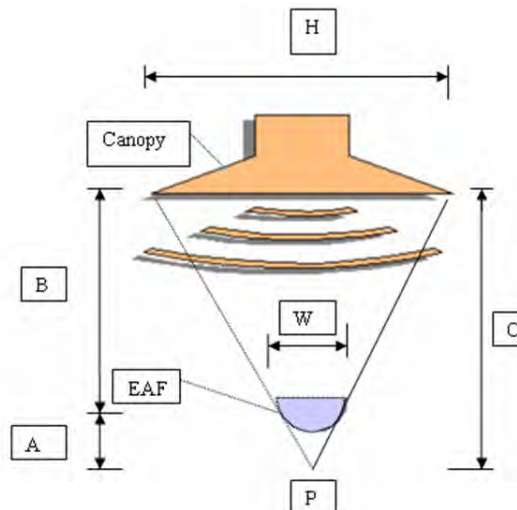

Figure 3-8: Conopy Size Over EAF

Minor emissions of particulates arise from ladle metallurgy processes and vacuum degassing and they are usually collected and cleaned by fabric filters – separate or common.

Recommended measures to prevent and control particulate matter emissions from EAFs include:

- Quick cooling of gas followed by bag filters. The bag filters can be primed with absorbents (*e.g.* lime or carbon) to further capture volatile impurities;
- Use of direct off-gas extraction and canopy hood enclosures and cleaning.

Recommended pollution prevention and control techniques to reduce CO emissions include the use of foamy slag practices in EAF process.

B. Chlorides and fluorides

HF and HCl may arise from off-gas in the EAF process, depending on the quality of the scrap charged. Recommended pollution prevention and control techniques include:

- Use of dry dedusting or wet scrubbing techniques, which are also typically installed to control particulate matter and sulphur oxide emissions respectively;
- Control the input of chlorine via raw materials through the materials selection process;
- Avoid spraying with sea water;

C. VOCs and organic HAPs

Volatile organic compounds (VOC) and polynuclear aromatic hydrocarbons (PAH) may be emitted from various stages in steel manufacturing from the EAF, especially when coal is added as a ‘nest’ to the scrap basket. PAH may also be present in the EAF scrap input, and may also be formed during EAF operation. Recommended pollution prevention and control techniques for VOC emissions include the following process integrated measures:

- Pre-treat mill scales through practices such as pressure washing to reduce oil content
- Optimize operation practices, particularly combustion and temperature controls
- Minimize oil input via mill scale through use of “good housekeeping” techniques

D. Dioxins and furans

Potential PCDD/F emissions source is off-gas in the EAF. The potential presence of polychlorinated biphenyls (PCB), PVC, and other organics in the scrap input (shredded scrap mainly obtained from old equipment or ship breakings) may be a source of concern, due to its high potential for PCDD/F formation. Recommended techniques to prevent and control PCDD/F emissions include the following:

- Use of clean scrap for melting
- Use of post combustion of the EAF off-gas to achieve temperatures above 1200 °C, and maximizing residence time at this temperature. The process is completed with a rapid quenching to minimize time in the dioxin reformation temperature range
- Use of oxygen injection to ensure complete combustion

- Injection of additive powders (*e.g.* activated carbons) into the gas stream to adsorb dioxins before the dust removal by filtration (with subsequent treatment as a hazardous waste)
- Installation of fabric filters with catalytic oxidation systems

E. Metals

Heavy metals may be present in off-gas fumes from thermal processes. The amount of metal emissions depends on the particular process type and on the composition of raw materials (scrap). Particulates from the EAF may contain zinc (which has the highest emission factor in EAFs, particularly if galvanized steel scrap is used); cadmium; lead; nickel; mercury; manganese; and chromium. Metal particulate emissions should be controlled with high efficiency dust abatement techniques applied to particulate emissions control as discussed above. Gaseous metal emissions are typically controlled through the cooling of gases followed by bag filters.

F. Wastewater

Major share of wastewater is generated from indirect cooling of furnace shell and water cooled duct. This wastewater is passed through the cooling towers after removal of oil and grease and recycled. Some effluent may be generated by the degassing process.

G. Solid Waste

Solid wastes from this industry primarily include steel skulls, slag, and waste refractories. Other solid wastes include sludge from effluent treatment and dust from dry dust collectors. Dust may contain dioxins and furans due to largely external (dirty) scrap consumption. The steel skulls are usually recycled, and other solid wastes are recycled, when appropriate, or disposed of in a landfill site.

EAFs produce a significant amount of slag, which is crushed and screened for recycle or sale. If reuse of EAF slag is not financially or technically feasible, it should be disposed off, along with the dust from the treatment of off-gas, in a landfill designed with consideration of slag and dust characteristics in line with Hazardous Waste (Management and Handling) Rules, Government of India. Local geological conditions should also be considered when locating slag heaps.

H. Noise

Raw and product material handling as well as the production processes within EAF, transport and ventilation systems may generate excessive noise levels. Recommended techniques to prevent, reduce, and control noise include the following:

- Enclose the process buildings and/or insulate structures
- Enclose fans, insulate ventilation pipes, and use dampers
- Adopt foaming slag practice in EAFs
- Limitation of scrap handling and transport during night time, where required

Table 3-5 provides examples of emission and waste generation indicators. World Bank (WB) – International Finance Corporation (IFC)- industry benchmark values are provided

here are for comparative purposes only and individual projects should target continual improvement in these areas.

Table 3-5: Emission / Waste Generation

Outputs per unit of product	Unit	Industry Benchmark
Emissions (1) (2)		EAF
Particulate Matter	kg/t product	0.02
CO	kg/t product	0.75- 4
NOx	kg/t product	0.12-0.25
PCDD/F	µgI TEQ/ t product	0.07- 9
Waste(1)		
Solid Waste	kg/t product	110- 180
1. European Commission, IPPC, “BREF Document on the Production of Iron and Steel” and “Reference Document in BAT in the Ferrous Metals Processing Industry” December 2001 2. UK Environmental Agency 2001, 2002. Technical Guidance Notes. IPPC S2.01, S2.04. Benchmark values.		

3.2.4 Specific consumption factors

3.2.4.1 Induction furnace

A coreless induction furnace is an efficient periodic action melting plant. The use of refractories per tonne of steel produced is at a minimum in these types of furnaces. A furnace of an output of 1 t/h has a refractory lining not more than 100 mm thick with a total mass of only 160 kg. The lining of an arc furnace of the same output weighs about 7 t.

An important index of furnace operation is the use of electric energy. The power supplied to a medium frequency induction furnace producing carbon steel may be distributed as follows:

Losses in converter	12-28%
Losses in capacitor and wiring	5-6%
Losses in inductor	11-16%
Radiant heat losses	8-10%
Heating of metal and slag	52-62%

With the total efficiency of the plant of 0.57, the use of electric energy is around 630 kWh/t steel melted, *i.e.*, only 10-30 kWh higher than that of a 3 t arc furnace melting scrap. The average use of electric energy in mains frequency furnaces is 550 kWh/t when melting foundry pig iron and around 730 kWh/t when melting steel for casting.

It should be remembered that the induction furnaces do not involve a loss of alloying elements, there is no loss of electrodes, and labour expenditure is low.

The following measures are essential for improving techno economic indices of induction furnaces:

- Install a sufficiently powerful generator
- Place the capacitors as close as possible to the furnace, since a high current flows in the capacitor's furnace circuit
- Install two inductors per generator
- Carefully select and weigh the charge so as to minimize the number of samplings during a heat
- Control the temperature of the cooling water so as to avoid needless wastage

3.2.4.2 EAF

A. Electrodes

An important characteristic of an EAF heat is the consumption of electrodes per tonne of steel produced. The types of electrodes used are carbon and graphite electrodes. The graphite electrodes are much superior to carbon electrodes as they have a 4 to 5 time greater electrical conductivity, which allows high current densities to be employed and lowers electrical losses. Graphite electrodes begin to oxidize at higher temperatures, can be easily machined, and their consumption per tonne of steel is only one half that of carbon electrodes. Graphite electrode consumption varies between 6 to 9 kg/ton, and that of carbon electrodes between 15 to 18 kg or more. Due to this reason, even with its high cost, graphite electrodes are popular. It has been observed that the consumption of electrodes increases initially with increasing capacity of furnace and then start decreasing beyond capacity of 40 tonne. At capacities more than 100 t, the electrode consumption comes around 5 kilogram per tonne (kg/T) for properly designed furnaces.

The factors that determine consumption of electrodes are as follows:

- Oxidation of surface of electrodes in the furnace by oxygen in the sucked in air
- Mechanical losses owing to fracture of electrodes
- Atomization by electric arc
- Dissolution in the slag during bath boil

The consumption of electrodes depends on furnace capacities, method and conditions of a heat, and also on the effective sealing of the electrode ports and the furnace doors. Approximately, two third of the total consumption of electrodes result from their oxidation due to poorly sealed furnace or a long operation with the furnace door left open.

The main rules of proper maintenance of electrodes during operation are as follows:

- Electrodes must be kept in dry place; if moisture is present in the electrodes, longitudinal or transverse cracks can form during rapid heating of the furnace, resulting in breakage
- The leakage of furnace gases through the gaps in the roof at the electrodes must be eliminated; this will lower the heating of the electrodes and their oxidation by atmospheric oxygen
- Electrode sections should be screwed tightly together

- The electrode holes in the roof should be positioned accurately; electrodes should move freely without touching the sealing rings and roof lining; if an electrode is subjected to lateral pressure during lowering, it may break
- The diameter of electrodes should correspond to the current supplied; if the current density is excessively high, electrodes will be heated and oxidized vigorously; if the electrode diameter is excessively large, energy consumption will be above normal

B. Electric Power / Oxygen

The performance of EAFs is assessed in terms of daily output in tons per 1000 kVA of power. Daily output is a function of nominal furnace capacity, working conditions, and the process adopted. On average, it is 3-14 tonnes per 1000 kVA. Energy consumption is likewise governed by the three above factors and amounts to 500 – 700 kWh per tonne for carbon steel up to 1000 kWh per tonne of alloy steel if only scrap is charged.

With increasing addition of liquid steel and HBI, considerable reduction in specific power consumption has been recorded with increase of specific oxygen consumption. An experiment with following performance procedure with changing charge mix was done as shown in Table 3-6.

Table 3-6: Performance Procedure

Trial step	Hot metal (%)	HBI (Midrex) (%)	Scrap* (%)
1	30	30	40
2	40	40	20
3	45	35	20
4	50	35	15
* including 5% pool iron			

With 30% hot metal, power consumption was around 400 kWh/t liquid steel and oxygen consumption around 28 Nm³/t liquid steel. With 40% hot metal, this is around 300 kWh/t liquid steel and around 35 Nm³/t liquid steel. The remarkable difference in power consumption of approximately 100 kWh/t between 30% and 40% hot metal is not significant because with 30% hot metal, it is necessary to first charge the scrap, then melt down the scrap for approx. 9 min. to get space in the furnace for the hot metal. The furnace is then switched off, the roof opened and the hot metal can be charged. This operation causes additional losses compared to step 2 to 4 with 40% – 50% hot metal input where the hot metal is poured to the scrap prior to power on after the end of charging, the furnace is switched on and operated without interruption until the end of the heat.

For 50% hot metal charging, specific power consumption values to approx. 250 kWh/t of liquid steel and oxygen consumption of approximately 40 Nm³/t hot metal can be achieved with silicon content of hot metal of 0.8%. Thus with higher hot metal charging rates into the EAF, consumption of electric energy and electrodes can be reduced.

3.2.4.3 Cupola furnace

Specific coke consumption norm in cupola per tonne of liquid metal is 135 kg/T (13.5 percentage charge coke). Experiments to replace coke with CNG are underway and no specific patterns can be derived.

Energy audits of a range of cupolas were conducted by The Energy and Resources Institute (TERI) in Howrah and Agra foundry clusters. The charge coke percentage, which is a measure of energy efficiency of a cupola, was found to vary over a wide range. The most energy efficient cupola was found to be using 13.6 % charge coke (coke:metal :: 1:7.5) and the least energy efficient cupola was operating at a charge coke percentage of 26.5 (coke:metal :: 1:4).

3.3 Qualitative and quantitative analysis of rejects

3.3.1 Induction furnace

Considering the temperature of charge, the volume of pot and continuous charging of input materials from the beginning up to a few minutes before tapping, it was found that total volume of gases including inspiration of air from surrounding atmosphere may reach a maximum of 6000 Nm³/h from a 1.5 to 2 t furnace. From test results it was found that hydrocarbons are about 40 mg/l and CO+CO₂ are less than 1 ppm. The SPM ranges from 125 to 450 mg/Nm³. If the charge consists of oily and highly rusted scrap, the SPM may go to 1000 mg/Nm³. SO₂ emission is less than 25 mg/Nm³. Suitable dust catcher like cyclones and/or wet scrubbers may be needed.

Considering the mixed steel scrap and sponge iron charge used in melting, it is found out that the particle size of dust varies from 0.7 to 80 μm and majority is between 0.7 to 7 μm. The SPM range in terms of weight will be 0.7 to 1.2 kg/t of steel or approximately 0.1% of steel scrap melted.

To make stainless steel ingots but using only induction furnace without using AOD converters, the charge consist of stainless steel melting scrap and no mild steel or sponge iron are used. To make up loss of manganese and chromium, low carbon ferrochrome and ferromanganese are used. Some nickel and copper elements are added. None of these inputs pose any environmental problems. Sometimes the turnings and borings in stainless steel scrap may contain very small quantities of soapy substance or oil. Such scrap is put in small furnace and heated to nearly 300⁰C. The test results show that SPM level is low; nearly 120 mg/Nm³. In rare cases it increases more than 200 mg/Nm³. It is learnt that some induction furnace units have installed simple exhaust systems and cyclones to take care of the pollutants.

Though the emission from induction furnaces is much less as compared to EAF, considering the probability of dirty charge composition and emission of pollutants, the following is recommended:

- Induction furnaces should be provided with fume extraction and dedicated pollution control systems consisting of swiveling hood, spark arrestor, bag filter or any other suitable dust catcher, ID fan and stack of suitable height
- A secondary fume extraction system with adequate side suction should be provided to prevent fugitive emissions during charging. The suction should be adequate to control fugitive emissions

Collected dust can be sold, provided it does not exhibit the properties of hazardous waste.

3.3.2 EAF

EAFs produce metal dusts, slag, and gaseous emissions. The primary hazardous components of EAF dust are zinc, lead, and cadmium; nickel and chromium are present when stainless steels are manufactured. The composition of EAF dust can vary greatly, depending on scrap composition and furnace additives. EAF dust usually has a zinc content of more than 15%, with a range of 5-35%. Other metals present in EAF dust include lead (2-7%), cadmium (generally 0.1-0.2% but can be up to 2.5% where stainless steel cases of nickel-cadmium batteries are melted), chromium (up to 15%), and nickel (up to 4%). Generally, an EAF produces 10 kg of dust per ton (kg/T) of steel, with a range of 5-30 kg/T, depending on factors such as furnace characteristics and scrap quality.

The EAF emissions are usually generated from three sources: charging, melting, and tapping. Melting emission (primary gases) can be captured by a fourth hole suction on the EAF casing. The quantity of primary gases exhausted from EAFs are to be calculated based on the oxygen flow rate to decarburize the charge and fresh air needed to burn CO to CO₂ for safety. Though cooling of the gas is done by the water cooled ducts, additional cooling air is needed to bring down temperature to suit fabric filter. In approximate calculations, the amount of process gases exhausted from the furnaces, in case of inspiration of air may be taken as 350 – 450 Nm³/T of crude steel.

Charging and tapping emissions are fugitive and gets released into the shop as a rising plume. The quantity may be 10 times or more of the primary fumes generation. Fume contained in the rising plume has to be exhausted from the melt shop by a roof mounted canopy. The evacuation system should be able to extract these emissions instantaneously as the arriving scrap bucket and cranes dispense them. The volume flow rate and emission level in the mushroom cloud is also increased if the steel maker places additives such as coal and lime into the scrap bucket. The following Table 3-7 summarizes the most important air emissions in EAF. The high temperature generated in the furnaces by the electric arc also brings about the formation of Cyanides and Fluorides.

Table 3-7: Air Emissions from Electric Arc Furnace

Emissions	kg/T iron produced
CO	0.5 - 19
Nox	0.02 - 0.3
VOC	0.03 - 0.15
Pb	0.005 - 0.05
PM	6.3

Source: Egyptian Pollution Abatement Project (EPAP)

An immense amount of heat, gases and fumes are generated during melting. Carbon monoxide (CO) can be generated in the production of steel in an EAF during decarburization of charge. Carbon containing compounds in the additives, scrap contamination, and particularly the foamy slag practice are the source of these emissions; (2.5 kg CO, 50 g SO₂, 0.25 kg NO₂, 100 g particulate) per tonne cast product. As the furnace contents are heated to approximately 1600°C, any metals that volatilize below this temperature will be carried away by the furnace off-gases. Thus, extremely fine dust is

formed as the result of evaporation of metal in the field of action of electric arc; the metal vapours are condensed and react with oxygen and nitrogen present in the furnace. The coarser fractions of dust are produced from the slag forming materials and ground reducing agents. When coke, coal, or limestone is injected into the furnace, fine particulates of these commodities may be drawn into the off-gas system. In EAF steel making, a fair amount of heavy solid particulate get injected into the off-gas. A furnace using the foamy slag practice can expect to collect 12 kg of dust per tonne of molten steel, but one could expect to collect more with unfavorable oxygen injection practices or too small a fourth hole due to large suction velocity. Furnace spout and furnace bottom tapping produce similar emissions. The emissions are mostly iron oxide and slag particulate. However, almost all EAF steel making processes add alloying elements of the ladle while tapping. This procedure can significantly increase tapping fume evolution. Therefore, the emissions, also, contain particulate consisting of oxides of these additives.

The Table 3-8 below shows the amount of dust exhausted from EAF per tonne of steel for different capacities of EAFs:

Table 3-8: Amount of Dust Exhausted from EAF per Tonne of Steel

Capacity of furnace, (tons)	Content of dust in gases, (g/m ³)
5	27
10	22
20	18
40	14
100	15

When steel is produced from dirty, rusty and small size scrap, the amount of dust can be twice the amount as given in Table 3-8. However, when reaching the fabric filter, this concentration will come down due to dilution by the addition of in leakage air, but may still remain between 1 to 10 g/m³.

During the production of steel in electric furnaces, traces of zinc in the charge volatilize due to the high temperature and condense in the dust collecting system as fine particles. This dust was usually discarded or sent to landfill. However, it was realized later that zinc in the dust may get solubilized and may contaminate surface or subterranean water. Processes were therefore developed to treat the dust to recover its zinc values before disposal.

3.3.3 Cupola furnace

Toxic emissions from cupolas include both organic and inorganic materials, which may be emitted directly or indirectly. Cupolas are the primary process of melting in foundries and also produce the most toxic emissions. It is estimated that 68.8 % of all the health risk from foundries is from foundries with cupolas. The emission factors are as given in Table 3-9.

Table 3-9: Cupola Furnace Emissions Criteria

Description	Value (mg/Mg Metal Melted)
PM ₁₀	6.2 x 10 ⁶
VOC	9 x 10 ⁴
NO _x	5 X10 ⁴
CO	7.25 X10 ⁷
SO ₂	1.8 X10 ³

(Source USEPA August 1990)

The cupola organic emissions factors which are of primary concern are:

- halogenated hydrocarbons: 1.92 mg/T metal melted
- aromatic hydrocarbons: 1.70 mg/T metal melted
- halogenated aromatics: 1.70 mg/T metal melted
- silicones: 0.43 mg/T metal melted
- heterocyclic N compounds: 0.16 mg/T metal melted
- amines: 0.14 mg/T metal melted

Inorganic emission factors for cupolas could not be obtained for most elements, however, the following emission factors are available:

- Arsenic: 26.1 mg/T
- Lead: 5 x 10⁴ - 5.5 x 10⁵ mg/T
- Manganese: 1.25 x 10⁵ mg/T
- Copper: 8.5 x 10² mg/T

Source: Criteria Emission, Cupola, USEPA August, 1990.

It is well-known that toxic inorganics such as cadmium and mercury are emitted during melting processes, notably the cupola, if present in the raw materials charged into the furnace. Individual cupola emissions vary widely, depending on the blast rate, blast temperature, melt rate, the coke to melt ratio and raw material composition. Although emission factors are not applicable to all cupolas because of this wide variation, emissions data per specific cupola may be used to project future emissions in the presence of process changes.

The impurities in raw materials may contribute to higher emission factors for halogenated hydrocarbons in cupolas and EAFs. High emission readings for chromium, lead and mercury are probably related to scrap quality and cleanliness. Dirty, oily and low quality metallic raw materials fed to the furnace charge preparation process will result in more emissions from the melting unit.

3.3.4 Exposure pathway

Exposure pathway is the path due to which exposure of the receptor takes place. “Exposure” is defined as contact with a chemical or physical agent. It is the process by which an organism acquires a dose. The estimation of exposure of a target organism requires an exposure scenario that answers to four questions:

- given the output of fate models, which media (ecosystem components) are significantly contaminated

Induction/Electric Arc/Cupola Furnaces Industry

- to which contaminated media are the target organisms exposed
- how are they exposed (pathways and rates of exposure)
- given an initial exposure, will the organism modify its behavior to modify exposure pathways or rates (attraction or avoidance)?

For Environmental Risk Management there are three major risk factors and exposure pathway is one of three factors. To determine whether risk management actions are warranted, the following assessment approach should be applied to establish whether the three risk factors of ‘contaminants’, ‘receptors’, and ‘exposure pathways’ co-exist, or are likely to co-exist, at the project site after the operational phase of the proposed development.

- Contaminant(s): Presence of pollutants and/or any hazardous materials, waste, or oil in any environmental media at potentially hazardous concentrations
- Receptor(s): Actual or likely contact of humans, wildlife, plants, and other living organisms with the contaminants of concern
- Exposure pathway(s): A combination of the route of migration of the contaminant from its point of release (*e.g.*, leaching into potable groundwater) and exposure routes

Table 3-10 identifies some of the major exposure pathways.

Table 3-10: Exposure Pathways

Media	Pathways	Comment
Air: Gases and Aerosols	Respiration	Assuming accurate fate model estimates, exposure is relatively predictable based on assumption of homogenous distribution in air
Water (Soluble Chemicals)	Respiration	Assuming accurate fate model estimates, exposure is relatively predictable based on assumption of homogenous distribution in water
Sediment (Solids and pore water)	Benthic animals absorb chemicals, respire pore water or food or food from the water column. Plants rooted in the sediment may take up material from sediments, surface water and air	Processes are very complicated and usually simplifying assumptions are required
Soil (solids, pore water and pore air)	Organisms in soils may absorb material from soil, pore water, pore air, ingest soil, soil – associated food.	Processes are very complicated and usually simplifying assumptions are required.
Ingested Food and Water	Consumption by fish and wildlife	Assume the test animal consumption rates in laboratory for a given availability of food or water are the same as those occurring naturally in the environment.
Multimedia	More than one of the above pathways	It is often possible to assume one pathway is dominant. In some

Media	Pathways	Comment
		cases, it will be necessary to estimate the combined dosage.

EAF and induction furnace plant emissions or rejects (gaseous, solid & hazardous as well as liquid effluents) can cause damage to human health, aquatic and terrestrial ecology as well as material due to various exposure routes (pathways). For example adverse effects of EAF and induction furnace plants on human health could be direct impact of noxious gases on the organism and/or indirect impact *via* the food chain and changes in the environment. Especially in connection with high levels of fine particulates, noxious gases like SO₂ and NO_x can lead to respiratory diseases. SO₂ and NO_x can have health-impairing effects even at concentrations below those of 2009 AAQ (24 hours avg.) standard of 80 µg/m³ for SO₂ and NO_x. The duration of exposure is decisive. Injurious heavy metals (*e.g.*, lead, mercury and cadmium) can enter the food chain and thus, the humans through drinking water/vegetables/animal products. Climatic changes such as warming and acidification of surface waters, forest depletion may occur due to acid rain and/or the greenhouse effect of CO₂ and other trace gases can have long-term detrimental effects on human health. Similarly important are the effects of climatic changes on agriculture and forestry (and thus on people’s standard of living), *e.g.*, large-scale shifts of cultivation to other regions and/or deterioration of crop yields due to climate change impacts. Hence, the construction and operation of EAF as well as the induction furnace plants can have both socio-economic and socio-cultural consequences. Appropriate preparatory studies, gender-specific and otherwise, are therefore required, and the state of medical services within the project area must be clarified in advance. Besides, noise pollution generated from turbines is an important source of Occupational exposure, has direct effects on humans and animals.

3.4 Technological Aspects

3.4.1 Cleaner technologies

Steel melting in EAF or induction furnace uses large quantities of raw materials, energy and water. As with any industry, these need to be managed well in order to maximize productivity and profits. As such, improving energy and resource efficiency should be approached from several directions. A strong corporate-wide energy and resource management program is essential. While process technologies described in Section 3.2 present well-documented opportunities for improvement, equally important is fine-tuning the production process, sometimes producing even greater savings. In section 3.3.1, are some measures concerning these and other general crosscutting utilities that apply to this industry.

3.4.1.1 DC arc furnace with water cooled furnace wall

Large energy saving is achieved in an EAF, which melts and refines ferrous materials such as steel scrap, by changing its power source from conventional three-phase AC to DC using a central electrode at top and bottom. The principle and mechanism are:

- it can melt materials uniformly
- the metal is melted and agitated by the electric current flowing through it and the magnetic field

- by adopting water cooled furnace wall, high efficiency operation is achievable

Energy Saving

- Specific power consumption is reduced by 5 to 10%
- Furnace maintenance materials are reduced
- Specific electrode consumption is reduced by 40 to 50%

Observations

DC arc furnaces are being used sparingly in Indian steel plants in place of AC arc furnaces, although energy efficient. ESSAR Steel in India is operating with DC-EAFs. The reasons of low penetration are as follows:

- High maintenance requirements
- DC electrical equipments are critical in nature; moreover erosion of bottom electrode is fast
- Investment cost is high and technology know-how is not easily available
- Grid has to be strengthened to absorb high surge

3.4.1.2 High frequency melting furnace

It is a melting furnace for steel such as stainless steel, cast steel, nickel, other alloy steel (by direct melting method); copper, brass, aluminum, noble metals and other non-ferrous metals (by indirect melting method in which carbon or metallic crucibles are used). The principles and mechanism are:

- frequency and power are selected
- high frequency induction current, with enhanced current density which is 2 to 5 times higher than that of low frequency method, is generated. The current generates heat by internal resistance of the material, and performs melting
- steel and alloy steel are melted by resistance heat generated by the induction current that flows in steel itself
- non-ferrous metals and nonmetals are heated and melted by conduction heat from induction heating elements such as graphite and metallic crucibles

Table 3-11 below compares a high frequency melting furnace with a low frequency melting furnace:

Table 3-11: Comparison of High and Low Frequency Melting Furnaces

Low Frequency Melting Furnace	High Frequency Melting Furnace
Cannot perform rapid melting because the electric current density needs to be maintained low in view of the agitating force. As it is difficult to inject electric power to small-sized materials, melting takes longer time.	Can rapidly melt small-sized materials. This is because high frequency current can penetrate deeper, and eddy current is generated even in small sized materials
Batch type intermittent operation needs a starting block or heel	Batch type intermittent operation is possible. A starting block or heel is not needed;

Induction/Electric Arc/Cupola Furnaces Industry

Low Frequency Melting Furnace	High Frequency Melting Furnace
The equipment cost is lower than that of a high frequency furnace.	As it needs a high frequency power source; the equipment cost is higher than that of a low frequency furnace.
	With high frequency current, larger electric power can be applied, and rapid melting is possible. As radiation heat loss is small, energy is saved

Energy saving

- Saving of specific power consumption for 3 T furnace : 12.3%
- Melting speed for a 3 T furnace (kg/h): Increase by 19.5%
- Electricity 750 kW for low frequency furnace but 1500 kW for high frequency furnace.

Observations

- High frequency melting furnace has inherent advantage of high melting rate of scrap leading to improved furnace productivity. This also increases the production capacity of the shop and reduces specific cost of production.
- Many of the induction furnace operators in India are engaged in production of various types of cast irons/steels/special quality products. Adopting high frequency melting furnaces through technology transfers would be quite beneficial from energy-saving-point which reduces specific energy costs and improves bottom line.

3.4.1.3 Channel type induction furnace for cast iron melting

Induction furnaces are of two types: crucible type and channel type. Recently the channel type is more widely used because of its higher overall heat efficiency. A crucible type furnace was conventionally used for melting cast iron, using coke or low frequency non-iron core induction as a heat source. The current trend is to perform continuous operation and save energy using a channel type low frequency furnace. The comparison is given in Table 3-12 and Table 3-13.

Table 3-12: Comparison of Crucible and Channel Type of Induction Furnace

Crucible Type Induction Furnace	Channel Type Induction Furnace
The assembly of this type consists of a crucible within a water-cooled copper coil and a framework on supports arranged for tilting during pouring. The primary circuit is formed by the coil, and the secondary circuit is the crucible or, rather, the charge in it. The lines of magnetic force link through the charge and induce eddy current in it, and the later generates heat.	A closed channel furnace comprises a cylindrical shaft, made of sheet iron and lined with refractory materials, and a bottom block which is enclosed in a detachable cast shell. An inductor is placed in the central portion of the iron core in hole provided in the bottom block. The metal that fills a narrow channel in the bottom block is heated by the induced current. After being placed into the shaft, the charge is melted owing to the intensive circulation of molten metal.

Table 3-13: Comparison of Energy Saving between Crucible and Channel Type

Item	Crucible Type	Channel Type
Power efficiency	60% - 80%	95% - 97%
Overall efficiency	55% – 65%	75% - 85%
Specific power consumption	High	Low
Need of heel	Not needed	Needed
Intermittent operation	Arbitrarily possible	Principally two shift or continuous operation

3.4.1.4 Ferroalloys Furnace for effective energy utilization

The electric furnace for smelting HC-FeCr (high carbon ferrochromium) refines chromium ore using coke as a reducing agent. However, as the ratio of fine chromium ore increased in recent years, permeability in the electric furnace decreased, and specific consumption of electric power and coke increased. The system described here reduces energy consumption for producing HC-FeCr, and recovers the combustible gas.

When fine chromium ore is agglomerated and calcined into pellets by an annular furnace, and the pellets are charged into the EAF in place of fine chromium ore, permeability in the furnace increases, which increases the heat exchange rate among charge materials, and decreases specific power consumption. Exhaust gas from the furnace is used as fuel of the burner for pellet calcinations. Excess gas is converted to steam for internal use.

Energy saving

- Electric power, *etc.*,
- Reduction in crude oil *e.g.*, when applied to 7 EAFs of more than 1000 kVA each, reduction in crude oil eq is 80,000 t/y.

3.4.1.5 Oxy-fuel burners/lancing

Oxy-fuel burners/lancing can be installed in EAFs to reduce electricity consumption by substituting electricity with oxygen and hydrocarbon fuels. They reduce total energy consumption because of:

- Reduced heat times, which save 2-3 kWh/tonne/min of holding time
- Increased heat transfer during the refining period
- Facilitates slag foaming, which increases efficiency of oxygen usage and injected carbon

Care must be taken to use oxy-fuel burners correctly, otherwise there is the risk that total energy consumption and greenhouse gases will increase.

Energy saving

- Electricity savings of 0.14 GJ/tonne crude steel, typical savings range from 2.5 to 4.4 kWh per Nm³ oxygen injection with common injection rates of 18 Nm³/t.

- Natural gas injection is 10 scf/kWh (0.3 m³/kWh) with typical savings of 20 to 40 kWh/T
- Retrofit Capital Costs of \$4.80/T crude steel on an EAF of 110 tonnes
- Improved heat distribution leads to reduced tap-to-tap times of about 6%, leading to estimated annual cost savings of \$4.0/T
- Reduction of nitrogen content of the steel, leading to improved product quality

3.4.1.6 Scrap preheating

Scrap preheating is a technology that can reduce the power consumption of EAFs through from using the waste heat of the furnace to preheat the scrap charge. Old (bucket) preheating systems had various problems, *e.g.*, emissions, high handling costs, and a relatively low heat recovery rate. Modern systems have reduced these problems and are highly efficient. The energy savings depend on the preheat temperature of the scrap. Various systems have been developed and are in use at various sites in the U.S. and Europe, *i.e.*, Consteel tunnel-type preheater, Fuchs Finger Shaft, and Fuchs Twin Shaft. All systems can be applied to new constructions, and also to retrofit existing plants.

A. Tunnel furnace - CONSTEEL process

The Consteel process consists of a conveyor belt with the scrap going through a tunnel, down to the EAF through a “hot heel”. Various U.S. plants have installed a Consteel process, as well as one plant in Japan.

Energy/Environment/Cost/Other Benefits Consteel process:

- Productivity increase of 33%
- Reduced electrode consumption of 40%
- Reduced dust emissions
- Electricity savings estimated to be 60 kWh/t for retrofits
- Annual operating cost savings of \$1.90/t crude steel (including productivity increase, reduced electrode consumption, and increased yield)
- Retrofit Capital Costs \$4.4 to \$5.5/t (\$2M for a capacity of 400,000 to 500,000 t/year)

B. Post consumption shaft furnace (FUCHS)

The FUCHS shaft furnace consists of a vertical shaft that channels the off-gases to preheat the scrap. The scrap can be fed continuously or through a so-called system of ‘fingers’. The optimal recovery system is the ‘double shaft’ furnace, which can only be applied for new construction. The Fuchs-systems make almost 100% scrap preheating possible, leading to potential energy savings of 100-120 kWh/t. Carbon monoxide and oxygen concentrations should be well controlled to reduce the danger of explosions, as happened at one plant in the U.S.

Energy saving

- Electricity savings of 120 kWh/t and fuel increases of 0.7 GJ/t
- Annual operating cost savings of \$4.5/t (excluding saved electricity costs)
- Retrofit Capital Costs of about \$6/t crude steel for and existing 100 t furnace

- Reduced electrode consumption
- Yield improvement of 0.25-2%
- Up to 20% productivity increase
- 25% reduced flue gas dust emissions (reducing hazardous waste handling costs)

3.4.1.7 Electrochemical dezincing

Dezincing of steel scrap improves recycling process. This electrochemical dezincing process provides an environmental friendly, economic method of removing zinc from steel scrap to reuse both the steel and zinc. With the use of zinc coated prompt scrap increasing, steelmakers are feeling the effect of increased contaminant loads on their operations. The greatest concerns are the cost of treatment before disposal of waste dusts and the water associated with remelting zinc coated scrap.

The process consists of two basic steps:

- dissolving the zinc coating from scrap in a hot, caustic solution, and
- recovering the zinc from the solution electrolytically.

Through a galvanic process, the zinc is removed from the steel and is in solution as sodium zincate ions rather than zinc dust. The steel is then rinsed with water and ready for reuse. Impurities are removed from the zinc solution, and then a voltage is applied in order to grow metallic zinc via an oxidation reduction reaction. All waste streams in this process are reused.

Benefits

- Pollution Reduction – Removal of zinc decreases steelmaking dust released to the air as well as pollutants in wastewater streams. The process itself does not consume any chemicals (other than drag out losses) and produces only a small amount of waste.
- Productivity – Removing zinc prior to processing of scrap saves time and money in disposal of waste dusts and water. Without the zinc, this high quality scrap does not require extra handling, blending, or sorting for remelting in steelmaking furnaces.

3.4.1.8 Divided blast cupola

Divided blast cupola (DBC) is a well-proven technology for improving the energy performance at a modest investment. A DBC supplies blast air to the cupola furnace at two levels through a double row of tuyeres almost equally divided between the top and bottom row of tuyeres, and the spacing between the tuyeres is about one metre apart, irrespective of the diameter of the cupola. Some comparative advantages of a DBC, as found in studies conducted by BCIRA, are given below:

- a higher metal tapping temperature (approximately 45-50°C more) and higher carbon pick-up (approximately 0.06%) are obtained for a given charge-coke consumption
- charge-coke consumption is reduced by 20-32% and the melting rate is increased by 11-23%, while maintaining the same metal tapping temperature

However, in the initial survey conducted at Agra and Howrah foundry clusters, it was found that conventional cupolas are commonly used by Indian foundry units and DBCs, where ever adopted, are of sub-optimal designs. Hence the intervention aims to

demonstrate and disseminate the benefits of a well - designed DBC among Indian foundries.

TERI's DBC design

TERI's DBC design incorporates the specific melting requirements of the individual foundry unit. Salient features of the cupola design include:

- Optimum selection of blower specifications (quantity and pressure)
- Optimum ratio of the air delivered to the top and bottom tuyers
- Minimum pressure drop and turbulence of the combustion air
- Separate wind-belts for top and bottom tuyeres
- Correct tuyere area, tuyere number and distance between the two rows of tuyeres
- Optimum well capacity
- Higher stack height
- Mechanical charging system
- Stringent material specifications

Energy savings and other benefits

A demonstration plant was installed at Bharat Engineering Works, Howrah, a unit nominated by the Indian Foundry Association (IFA). The foundry, manufacturing ingot moulds, had a charge coke percentage of 13.6 % (coke:metal :: 1:7.5) which was brought down to 8 % (coke:metal :: 1:12.5). Hence, the energy saving achieved in the new plant was about 40 % compared to their earlier cupola. On an average monthly melting of 430 tonnes, the yearly saving in coke is 270 tonnes which is equivalent to Rs. 8 lakh.

Additionally there was an increase in metal tapping temperature and reduction in silicon and manganese losses.

Energy saving of about 40 % was achieved in a replication unit setup at a foundry unit in Nagpur which makes thin-walled sanitary castings. The charge coke consumption reduced from 22 % (coke:metal :: 1:4.5) earlier to about 13 % (coke:metal :: 1: 7.7). This translates to a coke saving of 280 tonnes per annum (TPA) worth about Rs. 11 lakh on a melting of 300 tonnes per month in the foundry. The total capital investment of the cupola, inclusive of civil work, platforms, bucket charging system *etc.*, was about Rs. 12 lakhs. Thus the payback on the investment is one year considering savings in coke only. Additional benefits of DBC were – better analytical and temperature control of molten metal leading to substantial reduction in rejection of finished castings. The payback is more attractive, if the decrease in rejection rate of finished casting on account of better analytical and temperature control is considered

3.4.2 Pollution control technologies

3.4.2.1 EAF

In EAF operation, scarp, reduced iron and now-a-days hot metal is charged from the top into a refractory and water panel lined chamber. Swing roof, which is also lined with

refractory and water-cooled panel, is placed over the chamber. Through the roof three graphite electrodes are placed and connected to a powerful AC transformer which supplies the power necessary to melt the charge using high power arc discharge. The fume generated during the operation is aspirated through the fourth hole in the roof by creating a vacuum of about 1.5 to 2.5 mm H₂O inside the EAF casing, which is known as primary air. In-leakage air enters the casing through door openings, gaps of electrode holes, chute, *etc.* and decarburizes carbon. Additional oxygen may be supplied for complete decarburization of charge. The air rich in CO at a temperature of around 1700°C then passes through double-walled water-cooled elbow. Additional air is aspirated to combust balance CO to CO₂ from elbow gap. Hot gases are cooled through a water-cooled duct to around 550-600°C and then by a forced draft cooler before entering the bag filter at 120 – 130°C. If needed, additional air is sucked to the system. The bag filter is normally pulse jet type. Wet scrubbers were used earlier.

During charging, considerable amount of fugitive emissions arise which may be sucked through roof mounted canopy of adequate size. The quantity of suction air may be 10-15 times more than that of the primary air. This air may be added to the gas collection system through a mixing chamber, which also serves as a spark arrester, to cool the gases and taken to the bag filter to avoid installation of additional bag filter system. The canopy hood needs to suck less air during melting when the roof is closed and can be manipulated by a damper.

In many cases, especially in case of smaller capacity furnaces and high alloy steel making furnaces, where a small positive pressure is required in the furnace to create reducing condition, it would be advantageous to control the emissions by means of a side draft hood placed above the furnace roof or only by a roof mounted canopy, though its effectiveness is less. If the EAF is provided with a ladle refining unit, gases may be sucked from the refining ladle through a water-cooled duct and connected to the same system at mixing chamber.

The dust from the bag filter unit and mixing chamber is conveyed to a dust silo by mechanical or pneumatic conveying system. The dust is processed through a pug mill or pelletized before its final disposal/reuse. Dust recycling in the rotary hearth furnace (RHF) was applied at Nippon Steel's Kimitsu Works in 2000. The dust and sludge, in case of wet cleaning, along with iron oxide and carbon, are agglomerated into shaped articles and the iron oxide is reduced at high temperatures. Zinc and other impurities in the dust and sludge are expelled and exhausted into off-gas. Asahi Kyogyo in June 2007 used RHF to recycle 10,000 TPA EAF dust to EAF as DRI. So far, the EAF dust and slag are not being recycled or utilized in any way in the Indian steel works. These two by-products are being dumped. There is pressure from the regulatory body for alternate use of EAF dust as these are hazardous in nature. Pelletising of EAF dust is generally not practiced in Indian Electric Furnace steel making.

3.4.2.2 Induction furnace

From the description of pollution potential from induction furnaces, it may be observed that volume, quantity and harmful emission of solid and gaseous contaminants are fairly low as compared to EAF. The equipment need not be as elaborate as EAF so as to make it cost-effective for small-scale induction furnace units. At the same time, the pollutants emitted should be in conformity to regulations. The steps involved are: extraction of fumes; cleaning by cyclone separator; further cleaning of finer particulates in wet scrubber; and then allowing clean gases to pass to the environment. The last step is disposal of solid matter left as sludge or dust.

3.4.2.3 Cupola furnace

Emission reduction efforts include the use of bag houses, venturi scrubber, wet scrubbers, and afterburners to reduce particulates, CO and VOCs in cupola off-gases. Fabric filters are most effective in controlling cupola emissions, reducing manganese emissions from 250,000 to 300 mg/Mg. High energy scrubbers, impingement scrubbers and wet caps are used with less favorable results. Use of gas for heat and graphite for carbon may reduce emissions due to coke, which contributes to organics and trace inorganics.

The venturi scrubber is a highly efficient device for removing particulate matter and sulphur dioxide from stack gases. Since cupola stack gases contain a significant percentage of fine particulates, it was found that a venturi scrubber was the most effective device to bring down the emissions below the more stringent PEL of 150 mg/Nm³. Lime dosing can be done to maintain the pH of the recirculating water and reduce SO₂.

SPM and sulphur dioxide of the outlet gas from the pollution control device was measured which was installed at a foundry in Howrah. The SPM was found to be about 50 mg/Nm³ and sulphur dioxide was measured to be about 40 mg/Nm³.

Low cost wet scrubber dust emission control

National Productivity Council, Chennai has conducted a detailed investigation of the emissions from the cupola furnaces at Coimbatore. A low-cost wet scrubber system was designed and implemented by the units to control the dust emissions. It is a simple fabricate and install online process. No operator attention is necessary for scrubber operation. A water spray wet scrubber is designed concurrent to gas flow rate at the exit of the cupola furnace (Figure 3-9). The natural draft created (300°C – 400°C) by the cupola furnace is sufficient to draw the gases through the scrubber and there is no additional ID fan is necessary. A set of water spray nozzles scrub the dust laden gases. However to create additional draft to the cooled gases to discharge into atmosphere, an extended stack of diameter 1.0 ft and 6 ft high is installed at the exit of the scrubber. The scrubber water is collected in a sump to allow settling and separate the sludge and the clear water is re-circulated to the scrubber by 1HP centrifugal pump. Periodically the settled sludge is collected dried and disposed.

The water loss due to evaporation and along with sludge is about 5 m³ for 8 hours operation of cupola. The operating cost is only the power consumption by the recirculating pump, which is about < 10 units per day. The cost of the system is about Rs 70,000/- to Rs 80,000/-.



Figure 3-9: Low Cost Scrubber

Performance efficiency of the wet scrubber

The performance efficiency of the scrubber was assessed by collecting stack emission dust samples from the sampling port provided at the extended stack. Following are the emission monitoring results:

Table 3-12: Emission Monitoring Results

S. No	Parameter	Designed values	Measured values	Emission Standard by TNPCCB
1	Flow rate of gases, Nm ³ /hr	3000	2,300	-
2	Dust emissions after the scrubber, mg/Nm ³	< 150	47	150
3	Sulphur dioxide concentration, mg/Nm ³	300 - 400	< 50	-

3.5 Summary of Applicable National Regulatory Requirements

3.5.1 General description of major statutes

Government of India has published specific regulations and norms for the induction and electric arc furnace, submerged arc furnace and cupola in the Environmental (Protection) Rules, 1986 and its amendments. Detailed list is provided as **Annexure I**.

3.5.2 General standards for discharge of environmental pollutants

General standards for discharge of environmental pollutants as per CPCB are given in **Annexure II**.

3.5.3 Industry-specific standards

The electric furnace plays an important role in the recovery and recycling of waste iron resources. In areas where an abundant supply of scrap and electric power is available, the proportion of steel making *via* the electric furnace route is relatively high, because both energy consumption and equipment investment are substantially smaller in the integrated route using a blast furnace and basic oxygen furnace process to produce steel from ore.

Electric furnaces are classified as arc furnaces or induction furnaces. The arc furnace is used far more extensively for steelmaking, because its capacity is large and production efficiency is high. In addition to melting, both oxidation refining and reduction refining are possible in the arc furnace. The arc furnace is used for decarburization, dephosphorization, and dehydrogenation, and the induction furnace for desulphurization and deoxidation. The arc furnace is also capable of melting higher fraction of alloy scraps. The cupola is the only furnace using coke and is extensively used by foundries.

With the rapid industrialization, the consumption of steel continues to grow and as a result scrap generation will also continue to increase. Increased scrap generation in India and import from foreign countries means increased use of such furnaces, which requires adequate emission control and collection methods.

The objectives of the regulatory requirements are:

- To study and characterize fumes and emissions from induction and electric arc furnace, submerged arc furnace and cupola
- To study fugitive emissions during raw material handling, additives handling and tilting of pot/crucible for molten metal testing or during transferring
- To study noise pollution, minimization of fugitive emission and noise pollution, issues concerning generation, handling and disposal of slag (solid waste), suitable cost-effective modifications for better performance, effluent handling for ETPs (*i.e.* provided for air pollution control system); and
- To evolve with suitable environmental standards (emission, noise, effluent and solid waste) and good practice for induction and electric arc furnace, submerged arc furnace and cupola

Emission Standards

Table 3-13: Emission Standards - Foundries

Pollutant		Concentration (mg/Nm ³)	
(a)	Cupola Capacity (melting rate): Less than 3 tonne/hr	particulate matter	450
	3 tonne/hr and above	-do-	150

Induction/Electric Arc/Cupola Furnaces Industry

(b)	Arc Furnaces Capacity: All sizes	particulate matter	150
(c)	Induction Furnaces Capacity: All sizes	-do-	150

Source: CPCB

Table 3-14: Emission Standards – Cupola Furnace

Parameter	Emission limit
Sulphur dioxide (SO ₂)	300 mg/Nm ³ at 12% CO ₂ corrections

Source: CPCB

Table 3-15: OSHA standards for Permissible Noise Exposure

Duration Per Day, in Hours	Sound Level dB, Slow Response
8	90
6	92
4	95
3	97
2	100
1-1/2	102
1	105
1/2	110
1/4 or less	115

Note: When the daily noise exposure is composed of two or more periods of noise exposure of different levels, their combined effect should be considered, rather than the individual effect of each.

4. OPERATIONAL ASPECTS OF EIA

Prior environmental clearance process contained in the Notification issued on 14th September, 2006, and amended as on 1st December, 2009, fall into following four major stages *i.e.*, screening, scoping, public consultation and appraisal. Each stage has certain procedures to be followed. This section deals with all the procedural and technical guidance, for conducting objective-oriented EIA studies, their review and decision-making. Besides, the Notification also classifies projects into Category A, which requires prior environmental clearance from MoEF and Category B from SEIAA/UTEIAA.

Consistency with other requirements

- Clearance from other regulatory bodies is not a pre-requisite for obtaining the prior environmental clearance and all such clearances will be treated as parallel statutory requirements.
- Consent for Establishment (CFE) and Prior Environmental Clearance are two different legal requirements, a project proponent should acquire. Therefore, these two activities can be initiated and proceeded with simultaneously.
- If a falls within the purview of CRZ and EIA Notifications, then the project proponent is required to take separate clearances from the concerned Authorities.
- Rehabilitation and Resettlement (R&R) issues need not be dealt under the EIA Notification as other statutory bodies deal with these issues. However, socio-economic studies may be considered while taking environmental decisions.

4.1 Coverage of Induction/Arc/Cupola Furnaces under the Purview of the Notification

All Induction/arc/cupola furnace projects including expansion and modernization require prior environmental clearance. Based on pollution potential and capacities of the project, these are classified into Category A and Category B. Figure 4-1 shows the Categorization of projects.

Note:

(i) The recycling units registered under the HSM Rules, are exempted from purview of notification.

(ii) Plants/units other than power plants (given against entry no. 1 (d) of the Notification schedule), based on municipal solid waste (non-hazardous) are exempted. (Municipal solid waste in the context of this specific sector refers to segregated organic portion of municipal solid waste excluding recyclables and converted to pellets for use as a fuel.)

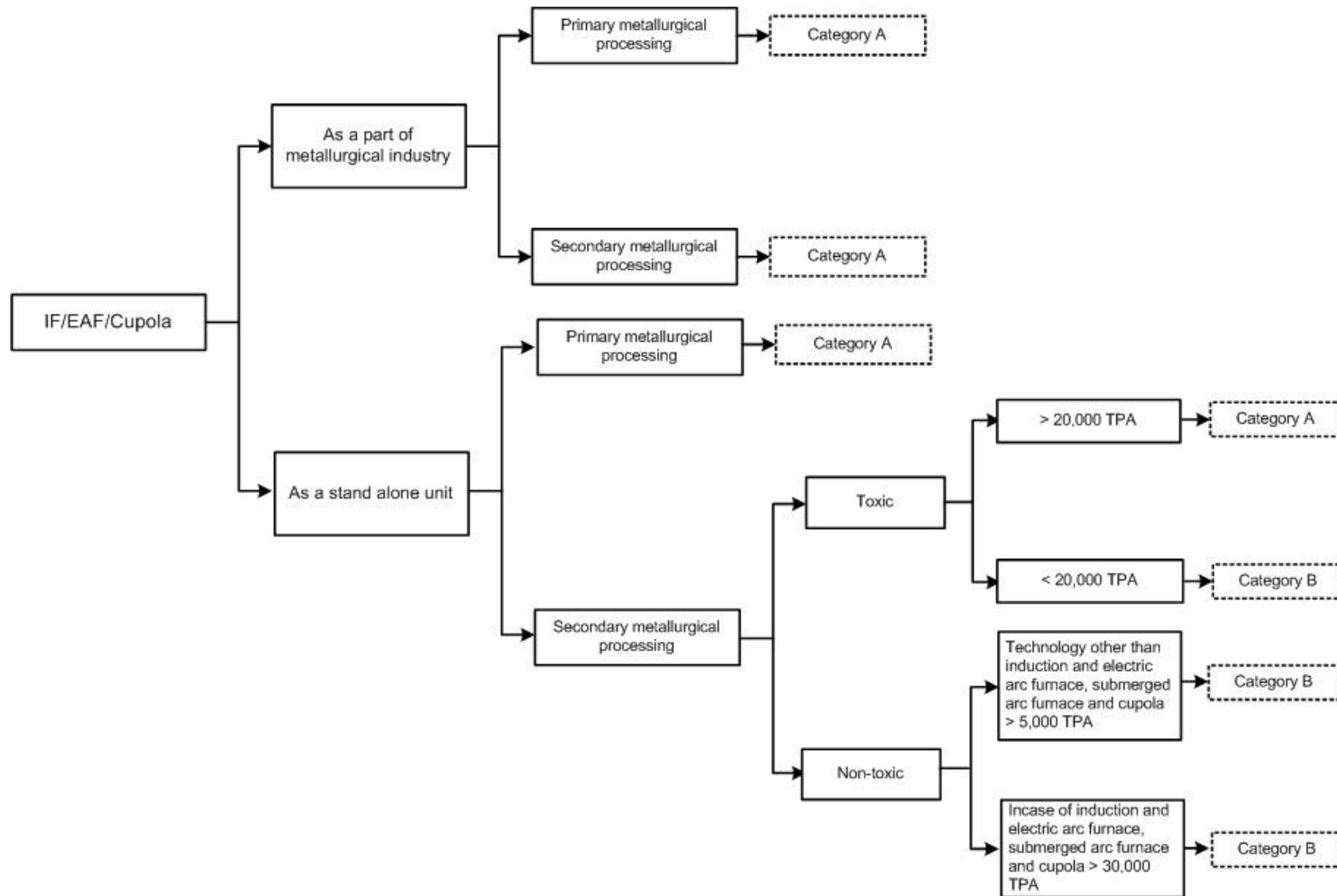

Figure 4-1: Categorization of Projects Under the Purview of Notification

Besides there are general conditions, when it applies, a Category B project will be appraised at the MoEF similar to that of Category A projects. These conditions are discussed in subsequent sections.

The sequence of steps in the process of prior environmental clearance for Category A projects and the Category B projects are shown in Figure 4-2 and Figure 4-3 respectively. The timelines indicated against each stage in the figures are the maximum permissible time lines set in the Notification for said task. In case the said task is not cleared/objected by the concerned Authority, within the specified time, said task is deemed to be cleared, in accordance to the proposal submitted by the proponent. Each stage in the process of prior environmental clearance for the induction and electric arc furnace, submerged arc furnace and cupola industries is discussed in subsequent sections.

In case of Expansion or Modernization of the developmental Activity:

- Any developmental activity, which has an EIA clearance (existing plant), when undergoes expansion or modernization (change in process or technology) with increase in production capacity or any change in product mix beyond the list of products cleared in the issued clearance is required to submit new application for EIA clearance.
- Any developmental activity, which is listed in Schedule of the EIA Notification and due to expansion of its total capacity, if falls under the purview of either Category B or Category A, then such developmental activity requires clearance from respective Authorities.

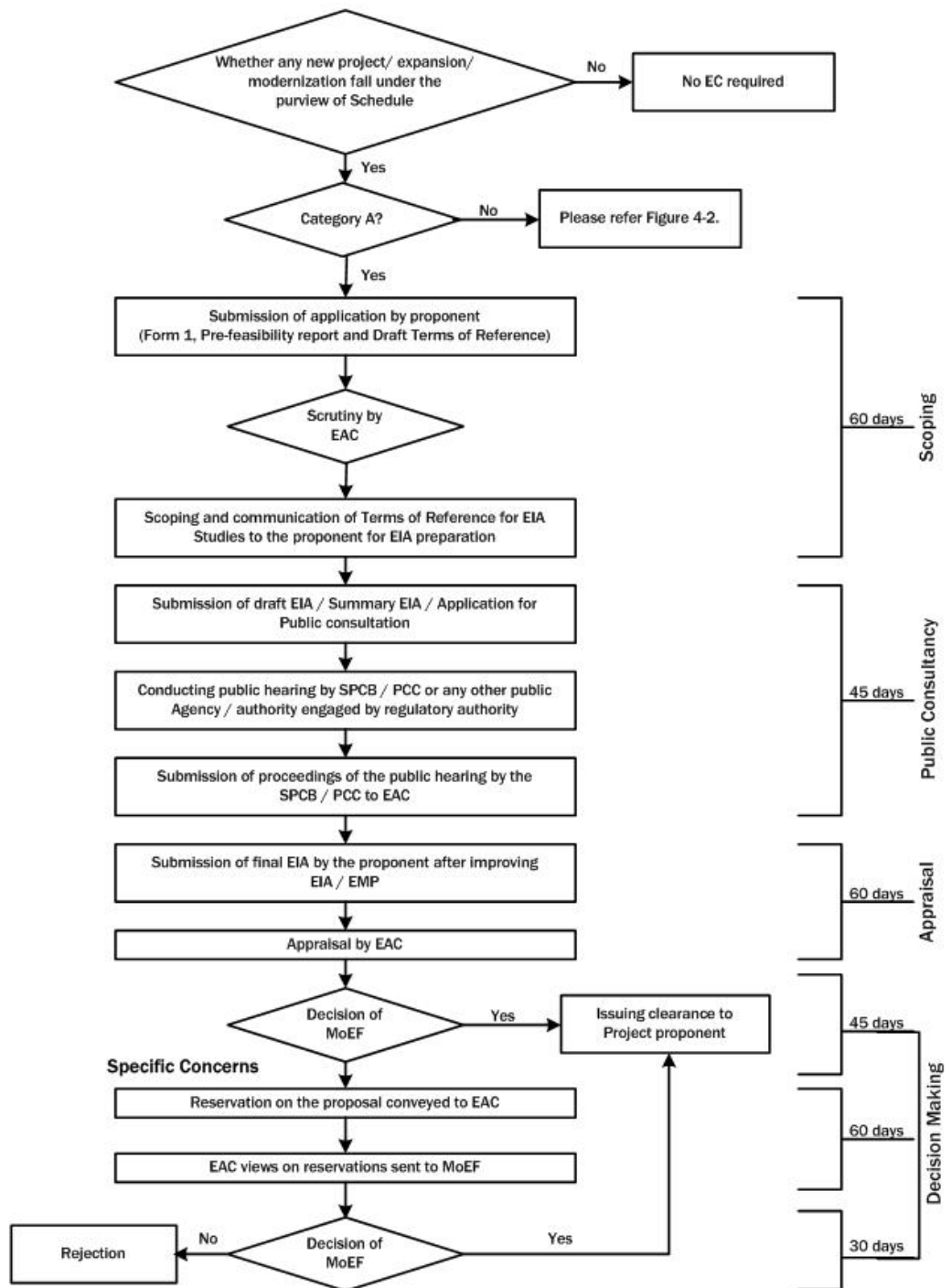

Figure 4-2: Prior Environmental Clearance Process for Activities Falling Under Category A

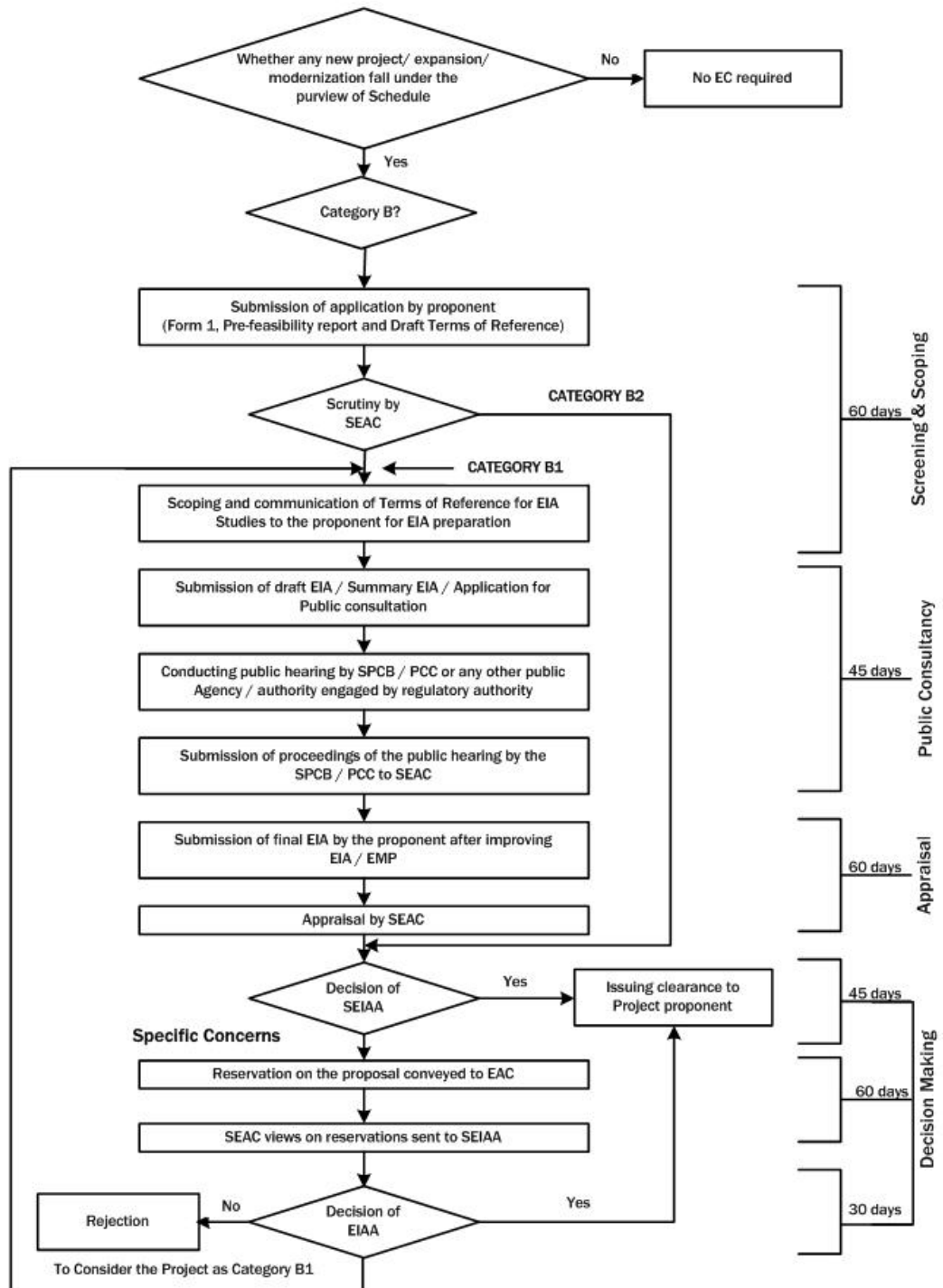

Figure 4-3: Prior Environmental Clearance Process for Activities Falling Under Category B

4.2 Screening

Screening of the project shall be performed at the initial stage of the project development so that proponents are aware of their obligations before deciding on the budget, project design and execution plan.

This stage is applicable only for Category ‘B’ developmental activity *i.e.* if general conditions are applicable for a Category B project, then it will be treated as Category A project. Besides, screening also refers to the classification of Category B projects into either Category B1 or Category B2. Category B1 projects require to follow all stages applicable for a Category A project, but are processed at the SEIAA/UTEIAA. Category B2 projects, on the other hand, do not require either EIA or public consultation.

As per the Notification, classification of the Category B projects falls under the purview of the SEAC. This manual provides certain guidelines to the stakeholders for classification of Category B1 and Category B2.

4.2.1 Applicable conditions for Category B projects

General condition

- Any induction and electric arc furnace, submerged arc furnace and cupola project (usually falling under Category B) will be treated as Category A, if located in whole or in part within 10 km from the boundary of:
 - Protected areas notified under the Wild Life (Protection) Act, 1972,
 - Protected areas notified under the Wild Life (Protection) Act, 1972
 - Critically polluted areas as notified by the CPCB from time to time
 - Eco-sensitive areas as notified under Section 3 of the E(P) Act, 1986, such as Mahabaleshwar Panchgani, Matheran, Panchmarhi, Dahanu, Doon valley
 - Inter-State boundaries and international boundaries – provided that the requirement regarding distance of 10 km of the inter-state boundaries can be reduced or completely done away with by an agreement between the respective States/UTs sharing the common boundary
- If any of the conditions listed in above general condition applies, then a Category B project will be treated as Category A
- The SEIAA shall base its decision on the recommendations of a State/UT level EAC for the purpose of prior environmental clearance
- In absence of a duly constituted SEIAA or SEAC, a Category B project shall be appraised at the Central level *i.e.*, at the MoEF
- The EAC at the State/UT level shall screen the projects or activities in Category B. SEAC shall meet at least once every month

4.2.2 Criteria for classification of Category B1 and B2 projects

The classification of Category B projects or activities of induction and electric arc furnace, submerged arc furnace and cupola into B1 or B2 will be determined based on whether or not the project or activity requires further environmental studies for preparation of an EIA for its appraisal prior to the grant of prior environmental clearance. The necessity of this will be decided, depending upon the nature and location specificity

of the project, by SEAC after scrutiny of the applications seeking prior environmental clearance for Category B projects or activities.

The projects requiring an EIA report shall be included in Category B1 and remaining projects will fall under Category B2 and will not require an EIA report and public consultation.

Situations which could be considered for Category B2 are:

For stand-alone units, furnaces of capacity > 30,000 TPA may be considered as B1 needing clearance. Furnaces of capacity \leq 30,000 TPA should be appraised by SEAC/SEIAA based on the submission of Form 1, conceptual plan and one season monitoring data by the project proponent to the State Authorities.

4.2.3 Application for prior environmental clearance

- The project proponent, after identifying the site and carrying out a pre-feasibility study, is required to apply for the prior environmental clearance using Form 1 given in **Annexure III**. The proponent has to submit the filled in Form 1 along with the pre-feasibility report and draft ToR for EIA studies to the concerned Authority *i.e.* MoEF, Government of India for Category A projects and the SEIAA in case of Category B projects. Please refer subsequent sections for the information on how to fill the Form 1, contents of pre-feasibility report and draft ToR for Induction/Cupola/Arc Furnaces industry.
- Prior environmental clearance is required before starting any construction work, or preparation of land on the identified site/project or activity by the project management, except for securing the land.
- If the application is made for a specific developmental activity, which has an inherent area development component as a part of its project proposal and the same project also attracts the construction and area development provisions under 8a and 8b of the Schedule, then the project will be seen as a developmental activity other than 8a and 8b of the Schedule.

4.2.4 Siting guidelines

These are the guidelines, stakeholders may consider while siting the developmental projects, to minimize the associated possible environmental impacts. In some situations, adhering to these guidelines is difficult and unwarranted. Therefore, these guidelines may be kept in the background, as far as possible, while taking the decisions.

Areas may be avoided

While siting industries, care should be taken to minimize the adverse impact of the industries on immediate neighborhood as well as distant places. Some of the natural life sustaining systems and some specific landuses are sensitive to industrial impacts because of the nature and extent of fragility. With a view to protect such sites, the industries may maintain the following distances, as far as possible, from the specific areas listed:

- Ecologically and/or otherwise sensitive areas: Preferably 5 km; depending on the geo-climatic conditions the requisite distance may be decided appropriately by the agency.
- Coastal areas: Preferably ½ km away from high tide line (HTL).

- Flood plain of the riverine system: Preferably ½ km away from flood plain or modified flood plain affected by dam in the upstream or flood control systems.
- Transport/Communication System: Preferably ½ km away from highway and railway line.
- Major settlements (3,00,000 population): Distance from major settlements is difficult to maintain because of urban sprawl. At the time of siting of the industry, if the notified limit of any major settlement is found to be within 50 km from the project boundary, the spatial direction of growth of the settlement for at least a decade must be assessed. Subsequently, the industry may be sited at least 25 km from the projected growth boundary of the settlement.
- Critically polluted areas identified by MoEF, from time to time. Current list of critically polluted areas is given in **Annexure IV**.

Note:

Ecological and/or otherwise sensitive areas include (i) Religious and Historic Places; (ii) Archaeological Monuments (e.g. identified zone around Taj Mahal); (iii) Scenic Areas; (iv) Hill Resorts; (v) Beach Resorts; (vi) Health Resorts; (vii) Coastal Areas rich in Corals, Mangroves, Breeding Grounds of Specific Species; (viii) Estuaries rich in Mangroves, Breeding grounds of Specific Species; (ix) Gulf Areas; (x) Biosphere Reserves; (xi) National Parks and Sanctuaries; (xii) Natural lakes, Swamps; (xiii) Seismic Zones; (xiv) Tribal Settlements; (xv) Areas of Scientific and Geological Interest; (xvi) Defence Installations, specially those of security importance and sensitive to pollution; (xvii) Border Areas (International) and (xviii) Air Ports.

Pre-requisite: State and Central Governments are required to identify such areas on a priority basis.

4.3 Scoping for EIA Studies

Scoping exercise is taken up soon after the project contours are defined. The primary purpose of scoping is to identify the concerns and issues which may affect the project decisions. Besides, scoping defines the requirements and boundaries of an EIA study.

Scoping refers to the process by which the EAC, in case of Category ‘A’ projects or activities, and SEAC in case of Category ‘B1’ projects, including applications for expansion and/or modernization of existing projects, determine ToR for EIA studies addressing all relevant environmental concerns for preparation of an EIA Report for a particular project.

- Project proponent shall submit application to concerned Authority. The application (Form 1 as given in **Annexure III**) shall be attached with pre-feasibility report and proposed ToR for EIA Studies. The proposed sequence to arrive at the draft ToR is discussed below:
 - Pre-feasibility report summarizes the project details and also the likely environmental concerns based on secondary information, which will be availed for filling Form 1.
 - From pre-feasibility report and Form 1, valued environmental components (VECs) may be identified for a given project (the receiving environment/social components, which are likely to get affected due to the project operations/activities).

Operational Aspects of an EIA

- Once the project details from the pre-feasibility report & Form 1; and VECs are identified, a matrix establishing the interactions which can lead to the effects/impacts could be developed (Qualitative analysis).
- For each identified possible effect in the matrix, significance analysis could be conducted to identify the impacts, which needs to be studied further (quantitative analysis) in the subsequent EIA studies. All such points will find a mention in the draft ToR to be proposed by the project proponent along with the application form. The draft ToR shall include applicable baseline parameters (refer annexure VI) and impact prediction tools proposed to be applied (refer annexure VIII).
- The information to be provided in pre-feasibility report, guidelines for filling Form 1 and guidelines for developing draft ToR is summarized in the subsequent sections.
- Authority consults the respective EAC/SEAC to reply to the proponent. The EAC/SEAC concerned reviews the application form, pre-feasibility report and proposed draft ToR by the proponent and make necessary additions/deletions to make it a comprehensive ToR that suits the statutory requirements for conducting the EIA studies.
 - The concerned EAC/SEAC may constitute a sub-committee for a site visit, if considered necessary. The sub-committee will act up on receiving a written approval from chairperson of the concerned EAC/SEAC. Project proponent shall facilitate such site visits of the sub-committees.
 - EAC/SEAC shall provide an opportunity to the project proponent for presentation and discussions on the proposed project and related issues as well as the proposed ToR for EIA studies. If the State Government desires to present its views on any specific project in the scoping stage, it can depute an officer for the same at the scoping stage to EAC, as an invitee but not as a member of EAC. However, non-appearance of the project proponent before EAC/SEAC at any stage will not be a ground for rejection of the application for the prior environmental clearance.
 - If a new or expansion project is proposed in a problem area as identified by the CPCB, then the Ministry may invite a representative of SEIAA to present their views, if any at the stage of scoping, to the EAC.
 - The final set of ToR for EIA Studies shall be conveyed to the proponent by the EAC/SEAC within sixty days of the receipt of Form 1 and pre-feasibility report. If the finalized ToR for EIA studies is not conveyed to the proponent within sixty days of the receipt of Form 1, the ToR suggested by the proponent shall be deemed as the final and will be approved for the EIA studies.
 - Final ToR for EIA Studies shall be displayed on the website of the MoEF/SEIAA.
 - Applications for prior environmental clearance may be rejected by the concerned Authority based on the recommendations by the concerned EAC/SEAC at the scoping stage itself. In case of such rejection, the decision together with reasons for the same shall be communicated to the proponent in writing within sixty days of the receipt of the application.
 - The final EIA report and other relevant documents submitted by the applicant shall be scrutinized by the concerned Authority strictly with reference to the approved ToR for EIA studies.

4.3.1 Pre-feasibility report

The pre-feasibility report should include, but not limited to highlight the proposed project information, keeping in view the environmental sensitivities of the selected site, raw material, technology options and its availability. Information required in pre-feasibility report varies from case to case even in same sector depending upon the local environmental setting within which the plant is located/proposed. However, the environmental information which may be furnished in the pre-feasibility report may include as under:

I. Executive summary

II. Project details: Description of the project including in particular;

- a description of the main characteristics of the production processes, for instance, nature and quantity of materials used,
- an estimate, by type and quantity, of expected residues and emissions (water, air and soil pollution, noise, vibration, light, heat, radiation, *etc.*) resulting from the operation of the proposed project.
- a description of the physical characteristics of the whole project and the land-use requirements during the construction and operational phases

III. Selection of site based on least possible impacts

- An outline of the main alternatives studied by the developer and an indication of the main reasons for this choice, taking into account the environmental effects.

IV. Anticipated impacts based on project operations on receiving environment

- A description of the aspects of the environment likely to be significantly affected by the proposed project, including, in particular, population, fauna, flora, soil, water, air, climatic factors, material assets, including the architectural and archaeological heritage, landscape and the inter-relationship between the above factors.
- A description of the likely significant effects of the proposed project on the environment resulting from:
 - existence of the project
 - use of natural resources
 - emission of pollutants, the creation of nuisances and the elimination of waste
 - project proponent's description of the forecasting methods used to assess the effects on the environment

V. Proposed broad mitigation measures which could effectively be internalized as project components to have environmental and social acceptance of the proposed site

- A description of key measures envisaged to prevent, reduce and where possible offset any significant adverse effects on the environment

VI. An indication of any difficulties (technical deficiencies or lack of know-how) encountered by the developer in compiling the required information

Details of the above listed points which may be covered in pre-feasibility report are listed in **Annexure V**.

4.3.2 Guidance for providing information in Form 1

The information given in specifically designed pre-feasibility report for this developmental activity may also be availed for filling Form 1.

Form 1 is designed to help users identify the likely significant environmental effects of proposed projects right at the scoping stage. There are two stages for providing information under two columns:

- First - identifying the relevant project activities from the list given in column 2 of Form 1. Start with the checklist of questions set out below and complete Column 3 by answering:
 - Yes - if the activity is likely to occur during implementation of the project
 - No - if it is not expected to occur
 - May be - if it is uncertain at this stage whether it will occur or not

- Second - Each activity for which the answer in Column 3 is “Yes” the next step is to refer to the fourth column which quantifies the volume of activity which could be judged as significant impact on the local environmental characteristics, and identify the areas that could be affected by that activity during construction /operation / decommissioning of the project. Form 1 requires information within 15 km around the project, whereas actual study area for EIA will be as prescribed by respective EAC/SEAC. Project proponent will need information about the surrounding VECs in order to complete this Form 1.

4.3.3 Identification of appropriate valued environmental components

VECs are components of natural resources and human world that are considered valuable and are likely to be affected by the project activities. Value may be attributed for economic, social, environmental, aesthetic or ethical reasons. VECs represent the investigative focal point for further EIA process. The indirect and/or cumulative effects can be concerned with indirect, additive or even synergistic effects due to other projects or activities or even induced developments on the same environmental components as would be considered direct effects. But such impacts tend to involve larger scale VECs such as within entire region, river basins or watersheds; and, broad social and economic VECs such as quality of life and the provincial economy. Once VECs are identified then appropriate indicators are selected for impact assessments on the respective VECs.

4.3.4 Methods for identification of impacts

There are various factors which influence the approach adopted for the assessment of direct, indirect, cumulative impacts, *etc.* for a particular project. The method should be practical and suitable for the project given the data, time and financial resources available. However, the method adopted should be able to provide a meaningful conclusion from which it would be possible to develop, where necessary, mitigation measures and monitoring. Key points to consider when choosing the method(s) include:

- Nature of the impact(s)
- Availability and quality of data
- Availability of resources (time, finance and staff)

The method chosen should not be complex, but should aim at presenting the results in a way that can be easily understood by the developer, decision maker and the public. A comparative analysis of major impact identification methods is given in Table 4-1:

Table 4-1: Advantages and Disadvantages of Impact Identification Methods

	Description	Advantages	Disadvantages
Checklists	<ul style="list-style-type: none"> Annotate the environmental features that need to be addressed when identifying the impacts of activities in the project 	<ul style="list-style-type: none"> Simple to understand and use Good for site selection and priority setting Simple ranking and weighting 	<ul style="list-style-type: none"> Do not distinguish between direct and indirect impacts Do not link action and impact The process of incorporating values can be controversial
Matrices	<ul style="list-style-type: none"> Identify the interaction between project activities (along one axis) and environmental characteristics (along other axis) using a grid like table Entries are made in the cells which highlights impact severity in the form of symbols or numbers or descriptive comments 	<ul style="list-style-type: none"> Link action to impact Good method for displaying EIA results 	<ul style="list-style-type: none"> Difficult to distinguish direct and indirect impacts Significant potential for double-counting of impacts
Networks	<ul style="list-style-type: none"> Illustrate cause effect relationship of project activities and environmental characteristics Useful in identifying secondary impacts Useful for establishing impact hypothesis and other structured science based approaches to EIA 	<ul style="list-style-type: none"> Link action to impact Useful in simplified form for checking for second order impacts Handles direct and indirect impacts 	<ul style="list-style-type: none"> Can become very complex if used beyond simplified version
Overlays	<ul style="list-style-type: none"> Map the impacts spatially and display them pictorially Useful for comparing site and planning alternatives for routing linear developments Can address cumulative effects Information incentive 	<ul style="list-style-type: none"> Easy to understand Good to display method Good siting tool 	<ul style="list-style-type: none"> Address only direct impacts Do not address impact duration or probability
GIS	<ul style="list-style-type: none"> Maps the impacts spatially and display them pictorially Useful for comparing site and planning alternatives for routing linear developments Can address cumulative 	<ul style="list-style-type: none"> Easy to understand Good to display method Good siting tool Excellent for impact 	<ul style="list-style-type: none"> Do not address impact duration or probability Heavy reliance on knowledge and data Often complex and expensive

Operational Aspects of an EIA

	Description	Advantages	Disadvantages
	<ul style="list-style-type: none"> ▪ effects ▪ Information incentive 	<ul style="list-style-type: none"> ▪ identification and analysis 	
Expert System	<ul style="list-style-type: none"> ▪ Assist diagnosis, problem solving and decision making ▪ Needs inputs from user by answering systematically developed questions to identify impacts and determine their mitigability and significance ▪ Information intensive, high investment methods of analysis 	<ul style="list-style-type: none"> ▪ Excellent for impact identification and analysis ▪ Good for experimenting 	<ul style="list-style-type: none"> ▪ Heavy reliance on knowledge and data ▪ Often complex and expensive

The project team made an attempt to construct an impact matrix considering major project activities (generic operations) and stage-specific likely impacts which is given in Table 4-2.

While the impact matrix is each project-specific, Table 4-2 may facilitate the stakeholders in identifying a set of components and phase-specific project activities for determination of likely impacts. However, the location-specific concerns may vary from case to case; therefore, the components even without likely impacts are also retained in the matrix for the location-specific reference.

The matrix lists the major project activities (impact producing actions) of the project in columns and the major environmental components likely to be impacted, either positively or negatively, in rows. Certain project activities have possible interactions with certain environmental components and these cells are marked with asterisk (*).

Table 4-2: Matrix of Impacts

			PHASE I				PHASE II									PHASE III					
			Pre -Construction				Construction/ Installation									Operation and Maintenance					
1	2	3	4	5	6	7	8	9	10	11	12	13	14	15	16	17	18	19	20	21	
ENVIRONMENT	Component	Project Activities Parameter/ factor	Detailed Topographic Survey	Land Acquisition	Site Clearing	Burning of wastes, refuse and cleared vegetation	Site Preparation / Change in Topography	Civil works such as earth moving and building of structures including temporary structures	Heavy Equipment operations	Disposal of construction wastes	Generation of sewage	Influx of construction workers	Deforestation	Transportation of material	Installation of equipment	Raw material storage, piling and handling	Crushing and Screening	Emissions from process	Effluent from process	EAF dust, Solid and Hazardous waste management	
Physical	Soil	Erosion Risks					*						*								
		Contamination						*		*						*	*		*	*	
		Soil Quality			*			*									*	*		*	
	Resources	Fuels/ Electricity													*		*	*			
		Raw materials							*							*					
		Land especially undeveloped or agricultural land		*						*						*					
		Water																			
	Water	Interpretation or Alteration of River Beds					*								*						
		Alteration of surface run-off and interflow			*		*	*													
		Alteration of aquifers					*	*													
		Water quality						*			*					*			*	*	*

Operational Aspects of an EIA

			PHASE I				PHASE II									PHASE III					
			Pre -Construction				Construction/ Installation									Operation and Maintenance					
1	2	3	4	5	6	7	8	9	10	11	12	13	14	15	16	17	18	19	20	21	
	Air	Temperature																	*		
		Air quality														*	*	*		*	
		Noise				*		*	*						*		*	*	*		
		Climate			*			*	*						*	*		*	*		
Biological	Terrestrial Flora	Effect on grass & flowers				*							*					*		*	
		Effect on trees & shrubs			*		*		*				*						*	*	
		Effect on farmland			*		*						*					*	*	*	
		Endangered species			*		*		*		*							*		*	
	Aquatic Biota	Habitat removal			*		*							*							
		Contamination of habitats			*		*														*
		Reduction of aquatic biota			*		*				*							*	*		
	Terrestrial Fauna	Fragmentation of terrestrial habitats			*		*														
		Disturbance of habitats by noise or vibration			*		*							*			*	*			
		Reduction of Biodiversity			*		*											*		*	
Social	Economy	Creation of new economic activities	*									*			*					*	
		Commercial value of properties											*			*		*	*		
		Conflict due to negotiation and/ compensation payments		*																	
		Generation of temporary and permanent jobs											*		*	*	*	*	*		

Operational Aspects of an EIA

			PHASE I				PHASE II										PHASE III				
			Pre -Construction				Construction/ Installation										Operation and Maintenance				
1	2	3	4	5	6	7	8	9	10	11	12	13	14	15	16	17	18	19	20	21	
		Effect on crops			*			*			*					*		*	*	*	
		Reduction of farmland productivity		*														*	*		
		Income for the state and private sector																			
		Savings in foreign currency for the state																			
	Education	Training in new technologies	*													*	*	*			
		Training in new skills to workers	*									*			*	*		*			
	Public Order	Political Conflicts		*																	
		Unrest, Demonstrations & Social conflicts		*								*				*		*	*	*	
	Infrastructure and Services	Conflicts with projects of urban, commercial or Industrial development	*					*													
	Security and Safety	Increase in Crime								*											
		Accidents							*					*	*	*					
	Health					*												*			
	Cultural	Land use			*		*									*			*	*	
		Recreation														*	*	*	*	*	
		Aesthetics and human interest								*			*			*	*	*	*	*	
		Cultural status																*	*	*	

Note:

1. Above table represents a model for likely impacts, which will have to be arrived at on a case-to-case basis, considering VECs and significance analysis (Ref Section 2.9).

2. Project activities are shown as indicative. However, in Form 1 (application for EIA Clearance), for any question for which answer is 'Yes', then the corresponding activity shall reflect in project activities. Similarly 'parameters'/'factors' will also be changed within a component in order to reflect the target species of prime concern in the receiving local environment.

4.3.5 Testing the significance of impacts

The following set of conditions may be used as the checklist for testing the significance of the impacts and also to provide information in (II) Activity, Column IV of Form 1.

- Will there be a large change in environmental conditions?
- Will new features be out-of-scale with the existing environment?
- Will the effect be unusual in the area or particularly complex?
- Will the effect extend over a large area?
- Will there be any potential for trans-frontier impact?
- Will many people be affected?
- Will many receptors of other types (fauna and flora, businesses, facilities) be affected?
- Will valuable or scarce features or resources be affected?
- Is there a risk that environmental standards will be breached?
- Is there a risk that protected sites, areas, features will be affected?
- Is there a high probability of the effect occurring?
- Will the effect continue for a long time?
- Will the effect be permanent rather than temporary?
- Will the impact be continuous rather than intermittent?
- If it is intermittent will it be frequent rather than rare?
- Will the impact be irreversible?
- Will it be difficult to avoid, or reduce or repair or compensate for the effect?

For each "Yes" answer in column 3, the nature of effects and reasons for it should be recorded in the column 4. The questions are designed so that an "Yes" answer in column 3, will generally point towards the need for analyzing for the significance and requirement for conducting impact assessment for the effect.

4.3.6 Terms of reference for EIA studies

ToR for EIA studies in respect of the Induction/arc furnaces/cupola furnaces industry may include, but not limited to the following:

1. Executive summary of the project – giving a *prima facie* idea of the objectives of the proposal, use of resources, justification, *etc.* In addition, it should provide a compilation of EIA report including EMP and the post-project monitoring plan in brief.

Project description

2. Justification for selecting the proposed unit size.

3. Land requirement for the project including its break up for various purposes and its availability and optimization.
4. Details of proposed layout clearly demarcating various units within the plant.
5. Complete process flow diagram describing each unit, its processes and operations, along with material and energy inputs and outputs (material and energy balance).
6. Details on design and manufacturing process for all the units.
7. Details on environmentally sound technologies for recycling of hazardous materials, as per CPCB Guidelines, may be mentioned in case of handling scrap and other recycled materials.
8. Details on proposed source-specific pollution control schemes and equipments to meet the national standards.
9. Details on requirement of raw materials, its source and storage at the plant.
10. Details on requirement of energy and water along with its source and authorization from the concerned department. Location of water intake and outfall points (with coordinates).
11. Details on water balance including quantity of effluent generated, recycled & reused. Efforts to minimize effluent discharge and to maintain quality of receiving water body.
12. Details of effluent treatment plant, inlet and treated water quality with specific efficiency of each treatment unit in reduction in respect of all concerned/regulated environmental parameters.
13. Details of the proposed methods of water conservation and recharging.
14. Sources of emissions, adequacy of control measures and monitoring protocol.
15. Details on composition, generation and utilization of waste/fuel gases.
16. Management plan for solid/hazardous waste generation, storage, utilization and disposal.
17. Details on toxic metal content in the waste material and its composition and end use (particularly of slag).
18. Details on toxic content (TCLP), composition and end use of chrome slag. Details on the recovery of the Ferro chrome from the slag and its proper disposal.
19. Details regarding infrastructure facilities such as sanitation, fuel storage, restroom, *etc.*, to be provided to the workers during construction as well as to the casual workers including truck drivers during operation phase.
20. In case of expansion of existing industries, remediation measures adopted to restore the environmental quality if the groundwater, soil, crop, air, *etc.*, are affected and a detailed compliance to the prior environmental clearance/consent conditions.
21. Any litigation pending against the project and /or any direction /order passed by any Court of Law related to the environmental pollution and impacts in the last two years, if so, details thereof.

Description of the environment

22. The study area shall be up to a distance of 10 km from the boundary of the proposed project site.

23. Topography of the study area.
24. Location of the project site, township and nearest villages with distances from the site to be demarcated on a toposheet (1: 50000 scale).
25. Land use based on satellite imagery including location of residential, national parks / wildlife sanctuary, villages, industries, all ecologically sensitive areas, *etc.* for the study area.
26. Demography details of all the villages falling within study area.
27. Baseline data to be collected from the study area w.r.t. different components of environment *viz.* air, noise, water, land, biology and socio-economics (please refer Section 4.4.2 for guidance for assessment of baseline components and identify attributes of concern). Actual monitoring of baseline environmental components shall be strictly according to the parameters prescribed in the ToR after considering the proposed coverage of parameters by the proponent in draft ToR and shall commence after finalization of ToR by the competent Authority.
28. Geological features and geo-hydrological status of the study area at solid waste dump zone.
29. Surface water quality of nearby water sources and other surface drains.
30. Details on ground water quality.
31. Details on water quality for parameters pH, temperature, COD, Biochemical oxygen demand (27°C, 3 days), TDS*, Suspended solids*, Phenolic compounds (As C₆H₅OH)*, Cyanides (As CN)*, Oil & grease*, Ammonical nitrogen (As N)*, chlorides*, sulphides*, *etc.* (* - As applicable)
32. Details of existing ambient air quality for the parameters, SO₂*, NO_x*, PM₁₀*, PM_{2.5}*, O₃*, Pb*, CO*, C₆H₆*, benzo(a)pyrene (BaP)*, *etc.* and evaluation of the adequacy of the proposed pollution control devices to meet gaseous emissions and dust fall data with heavy metal analysis. (* - as applicable)
33. Details on stack and fugitive emissions for SPM*, PM₁₀*, PM_{2.5}*, SO₂*, NO_x*, HC*, CO*, acid mist*, VOC* and Benzopyrenes* (at ground level) and evaluation of the adequacy of the proposed pollution control devices to meet gaseous emissions and dust fall data with heavy metal analysis. (* - as applicable)
34. The air quality contours may be plotted on a location map showing the location of project site, habitation nearby, sensitive receptors, if any and wind roses.
35. At least one season data of three continuous months with average, range and 98 percentile value for each parameter of concern for gaseous emissions for existing plants other than monsoon season.
36. Details on noise level at sensitive/commercial receptors.
37. Proposed baseline monitoring network for the consideration and approval of the Competent Authority.
38. Site-specific or published secondary micro-meteorological data including mixing height.
39. Ecological status (terrestrial and aquatic) of the study area such as habitat type and quality, species, diversity, rarity, fragmentation, ecological linkage, age, abundance, *etc.*
40. If any incompatible land use attributes fall within the study area, proponent shall describe the sensitivity (distance, area and significance) and propose the additional

points based on significance for review and acceptance by the EAC/SEAC. Incompatible land use attributes include:

- Public water supply areas from rivers/surface water bodies, from ground water
- Scenic areas/tourism areas/hill resorts
- Religious places, pilgrim centers that attract over 10 lakh pilgrims a year
- Protected tribal settlements (notified tribal areas where industrial activity is not permitted)
- Monuments of national significance, World Heritage Sites
- Cyclone, Tsunami prone areas (based on last 25 years)
- Airport areas
- Any other feature as specified by the State or local government and other features as locally applicable, including prime agricultural lands, pastures, migratory corridors, *etc.*

41. If ecologically sensitive attributes fall within the study area, proponent shall describe the sensitivity (distance, area and significance) and propose the additional points based on significance for review and acceptance by the EAC/SEAC. Ecological sensitive attributes include:

- National parks
- Wild life sanctuaries Game reserve
- Tiger reserve/elephant reserve/turtle nesting ground
- Mangrove area
- Wetlands
- Zoological gardens
- Reserved and protected forests
- Any other closed/protected area under the Wild Life (Protection) Act, 1972,
- Any other eco-sensitive areas.

42. If the location falls in Valley, specific issues connected to the natural resources management shall be studied and presented.

43. If the location falls in CRZ area: A CRZ map duly authenticated by one of the authorized agencies demarcating LTL, HTL, CRZ area, location of the project and associate facilities w.r.t. CRZ, coastal features such as mangroves, if any.

- Provide the CRZ map in 1:10000 scale in general cases and in 1:5000 scale for specific observations.
- Proposed site for disposal of dredged material and environmental quality at the point of disposal/impact areas.
- Fisheries study should be done w.r.t. Benthos and Marine organic material and coastal fisheries.

Anticipated environmental impacts and mitigation measures

44. Anticipated generic environmental impacts due to the project are indicated in Table 4-2, which may be evaluated for significance and based on corresponding likely impacts VECs may be identified. Baseline studies may be conducted for all these concerned VECs and likely impacts will have to be assessed for their magnitude in order to identify mitigation measures (please refer Chapter 4 of the manual for guidance).

45. Tools as given in Section 4.4.3 may be referred for the appropriate assessment of environmental impacts and same may be submitted in draft ToR for consideration and approval by EAC/SEAC.
46. While identifying the likely impacts, also include the following for analysis of significance and required mitigation measures:
 - impacts due to transport of raw materials and end/finished products
 - impacts due to fugitive emissions, stack emissions and other emissions on ambient air quality
 - impacts due to furnace operations
 - impacts due to wastewater discharge
 - impact due to project activities on health of workers/nearby residents
 - impacts due to noise
 - impact on local infrastructure due to project and any other project-specific significant impacts
47. In case of likely impact from the proposed facility on the surrounding reserve forests, if any, conservation Plan for wild fauna in consultation with the State Forest Department.
48. For identifying the mitigation measures, please refer Chapter III for source control and treatment. Besides typical mitigation measures which may also be considered are discussed in Table 4-5.
49. Proposed measures for occupational health and safety of the workers
50. Action plan for green cover development including the details of species, width of plantation, planning schedule, *etc.*, in accordance to CPCB published guidelines
51. Details on treatment of wastewater from different units, recycle and reuse for different purposes.
52. Hazard identification taking resources to hazardous indices, inventory analysis, natural hazardous probability, *etc.*, Consequent analysis of failure and accidents resulting in release of hazardous substances.
53. Details on surface as well as roof top rainwater harvesting and groundwater recharge.
54. Action plan for solid/hazardous waste generation, storage, utilization and disposal.
55. Training programs to employers for regulated areas regarding occupational safety and health hazards, exposure to emissions, purpose, proper use and limitations of respiratory protective devices, *etc.*

Analysis of alternative resources and technologies

56. Comparison of alternate sites considered and the reasons for selecting the proposed site. Conformity of the site with the prescribed guidelines in terms of CRZ, river, highways, railways, *etc.*
57. Details on improved technologies.

Environmental monitoring program

58. Monitoring at source/control equipment
59. Monitoring of pollutants at receiving environment (ambient and work zone) for all the appropriate notified parameters – air quality, groundwater, surface water, *etc.*, during operational phase of the project.

60. Identifying the regulated areas in the plant and regular monitoring of these areas for concerned pollutants.
61. Details of monitoring network proposed for regulatory compliance and to assess the residual impacts on VECs, if any.
62. Details of in-house monitoring capabilities and the recognized agencies if proposed for regular monitoring.

Additional studies

63. Details on risk assessment and damage control during different phases of the project and proposed safeguard measures.
64. Details on socio-economic development activities such as commercial property values, generation of jobs, education, social conflicts, cultural status, accidents, *etc.*
65. Proposed plan to handle the socio-economic influence on the local community. The plan should include quantitative dimension as far as possible.
66. Details on compensation package for the people affected by the project, considering the socio-economic status of the area, homestead oustees, land oustees, and landless labourers.
67. Points identified in the public hearing and commitment of the project proponent to the same. Detailed action plan addressing the issues raised, and the details of necessary allocation of funds.
68. Details on plan for corporate social responsibility including the villages, population spread, SC/ST/backward communities, upgradation of existing schools, establishing new schools with facilities (such as laboratories, toilets, *etc.*), link roads, community halls, primary health facilities, health camps, *etc.*

Environmental management plan

69. Administrative and technical organizational structure to ensure proposed post-project monitoring programme for approved mitigation measures.
70. EMP devised to mitigate the adverse impacts of the project should be provided along with item-wise cost of its implementation (Capital and recurring costs).
71. Allocation of resources and responsibilities for plan implementation.
72. Details of the emergency preparedness plan and on-site and off-site disaster management plan.

Note:

Above points shall be adequately addressed in the EIA report at corresponding chapters, in addition to the contents given in the reporting structure (Table: 4-6).

4.4 Environmental Impact Assessment

The generic approach for accomplishing EIA studies is shown in Figure 4-4. Each stage is discussed, in detail in subsequent sections.

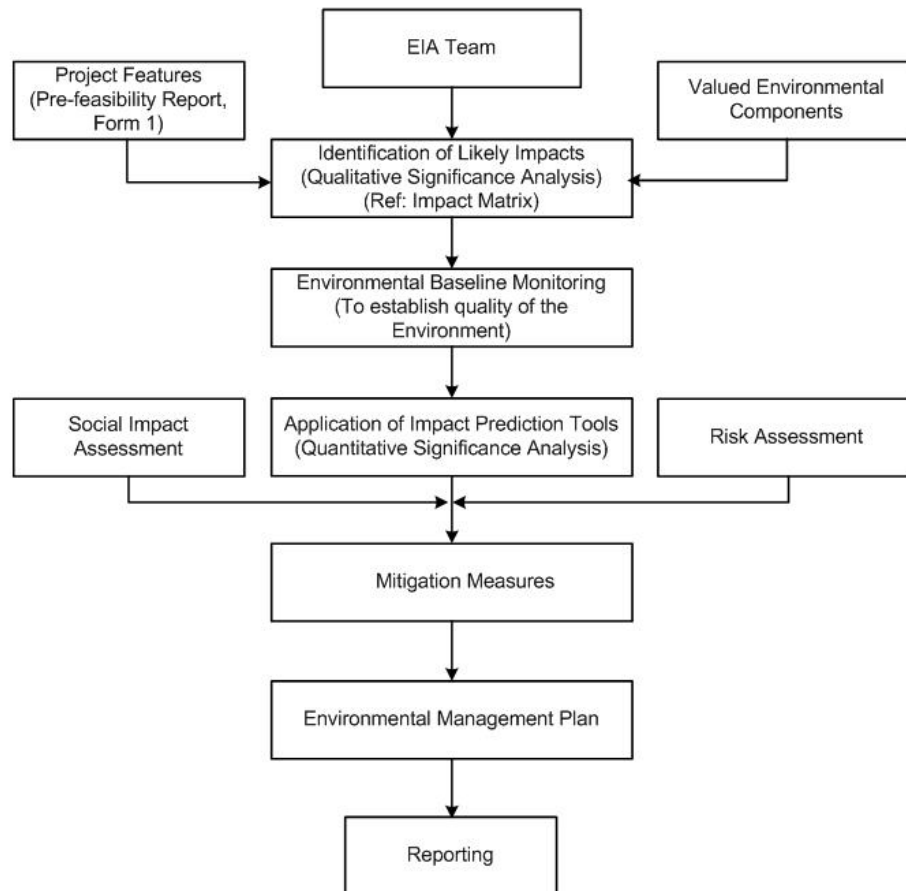

Figure 4-4: Approach for EIA Study

4.4.1 EIA team

The success of a multi-functional activity like an EIA primarily depends on constitution of a right team at the right time (preferable at the initial stages of an EIA) in order to assess the significant impacts (direct, indirect as well as cumulative impacts).

The professional Team identified for a specific EIA study should consist of qualified and experienced professionals from various disciplines in order to address the critical aspects identified for the specific project. Based on the nature and the environmental setting, following professionals may be identified for EIA studies:

- Environmental management specialist/regulator
- Mineral exploration and beneficiation specialist
- Metal technologist
- Air and noise quality specialist
- Occupational health specialist
- Ecologist
- Transportation specialist
- Safety and health specialist
- Social scientist, *etc.*

4.4.2 Baseline quality of the environment

EIA Notification 2006 specifies that an EIA Report should contain a description of the existing environment that would be or might be affected directly or indirectly by the proposed project. Environmental Baseline Monitoring (EBM) is a very important stage of EIA. On one hand EBM plays a very vital role in EIA and on the other hand it provides feedback about the actual environmental impacts of a project. EBM, during the operational phase, helps in judging the success of mitigation measures in protecting the environment. Mitigation measures, in turn are used to ensure compliance with environmental standards, and to facilitate the needed project design or operational changes.

Description of the existing environment should include natural, cultural, socio-economic systems and their interrelationships. The intention is not to describe all baseline conditions, but to focus the collection and description of baseline data on those VECs that are important and are likely to be affected by the proposed industrial activity.

4.4.2.1 Objective of EBM in EIA context

The term 'baseline' refers to conditions existing before development. EBM studies are carried out to:

- identify environmental conditions which might influence project design decisions (*e.g.*, site layout, structural or operational characteristics);
- identify sensitive issues or areas requiring mitigation or compensation;
- provide input data to analytical models used for predicting effects;
- provide baseline data against which the results of future monitoring programs can be compared.

At this stage of EIA process, EBM is primarily discussed in the context of first purpose wherein feedback from EBM programs may be used to:

- determine available assimilative capacity of different environmental components within the designated impact zone and whether more or less stringent mitigation measures are needed
- improve predictive capability of EIAs

There are many institutional, scientific, quality control, and fiscal issues that must be addressed in implementation of an environmental monitoring program. Careful consideration of these issues in the design and planning stages will help avoid many of the pitfalls associated with environmental monitoring programs.

4.4.2.2 Environmental monitoring network design

Monitoring refers to the collection of data through a series of repetitive measurements of environmental parameters (or, more generally, to a process of systematic observation). Design of the environmental quality monitoring programme depends up on the monitoring objectives specified for the selected area of interest. Types of monitoring and network design considerations are discussed in **Annexure VI**.

4.4.2.3 Baseline data generation

List of important physical environmental components and indicators of EBM are given in Table 4-3.

Table 4-3: List of Important Physical Environment Components and Indicators of EBM

Environmental Component	Environmental Indicators
Climatic variables	<ul style="list-style-type: none"> ▪ Rainfall patterns – mean, mode, seasonality ▪ Temperature patterns ▪ Extreme events ▪ Climate change projections ▪ Prevailing wind - direction, speed, anomalies ▪ Relative humidity ▪ Stability conditions and mixing height <i>etc.</i>
Topography	<ul style="list-style-type: none"> ▪ Slope form ▪ Landform and terrain analysis ▪ Specific landform types <i>etc.</i>
Coastal dynamics and morphology	<ul style="list-style-type: none"> ▪ Wave patterns ▪ Currents ▪ Shoreline morphology – near shore, foreshore ▪ Sediment – characteristics and transport <i>etc.</i>
Soil	<ul style="list-style-type: none"> ▪ Type and characteristics ▪ Porosity and permeability ▪ Sub-soil permeability ▪ Run-off rate ▪ Infiltration capacity ▪ Effective depth (inches/centimeters) ▪ Inherent fertility ▪ Suitability for method of sewage disposal <i>etc.</i>
Drainage	<ul style="list-style-type: none"> ▪ Surface hydrology ▪ Natural drainage pattern and network ▪ Rainfall runoff relationships ▪ Hydrogeology ▪ Groundwater characteristics – springs, <i>etc.</i>
Water quality	<ul style="list-style-type: none"> ▪ Raw water availability ▪ Water quality ▪ Surface water (rivers, lakes, ponds, gullies) – quality, water depths, flooding areas, <i>etc.</i> ▪ Ground water – water table, local aquifer storage capacity, specific yield, specific retention, water level depths and fluctuations, <i>etc.</i> ▪ Coastal ▪ Floodplains ▪ Wastewater discharges ▪ Thermal discharges ▪ Waste discharges, <i>etc.</i>
Air quality	<ul style="list-style-type: none"> ▪ Ambient ▪ Work zone ▪ Airshed importance ▪ Odour levels, <i>etc.</i>
Noise	<ul style="list-style-type: none"> ▪ Identifying sources of noise

Environmental Component	Environmental Indicators
	<ul style="list-style-type: none"> ▪ Noise due to traffic/transportation of vehicles ▪ Noise due to heavy equipment operations ▪ Duration and variations in noise over time, <i>etc.</i>
Biological	<ul style="list-style-type: none"> ▪ Species composition of flora and fauna ▪ Flora – type, density, exploitation, <i>etc.</i> ▪ Fauna – distribution, abundance, rarity, migratory, species diversity, habitat requirements, habitat resilience, economic significance, commercial value, <i>etc.</i> ▪ Fisheries – migratory species, species with commercial/recreational value <i>etc.</i>
Landuse	<ul style="list-style-type: none"> ▪ Landuse pattern, <i>etc.</i>

Guidance for assessment of baseline components and attributes describing sampling network, sampling frequency, method of measurement is given in **Annexure VII**.

Infrastructure requirements for EBM

In addition to devising a monitoring network design and monitoring plans/program, it is also necessary to ensure adequate resources in terms of staffing, skills, equipment, training, budget, *etc.*, for its implementation. Besides assigning institutional responsibility, reporting requirements, QA/QC plans and its enforcement capability are essential. A monitoring program that does not have an infrastructural support and QA/QC component will have little chance of success.

Defining data statistics/analyses requirements

The data analyses to be conducted are dictated by the objectives of environmental monitoring program. Statistical methods used to analyze data should be described in detail prior to data collection. This is important because repetitive observations are recorded in time and space. Besides, the statistical methods could also be chosen so that uncertainty or error estimates in the data can be quantified. For *e.g.*, statistical methods useful in an environmental monitoring program include: 1) frequency distribution analysis; 2) analysis of variance; 3) analysis of covariance; 4) cluster analysis; 5) multiple regression analysis; 6) time series analysis; 7) the application of statistical models.

Use of secondary data

The EBM program for EIA can at best address temporal and/or spatial variations limited to a limited extent because of cost implications and time limitations. Therefore analysis of all available information or data is essential to establish the regional profiles. So all the relevant secondary data available for different environmental components should be collated and analyzed.

To facilitate stakeholders, IL&FS Ecosmart Ltd., has made an attempt to compile the list of information required for EIA studies and sources of secondary data, which are given in **Annexure VIIIA** and **Annexure VIIIB**.

4.4.3 Impact prediction tools

The scientific and technical credibility of an EIA relies on the ability of EIA practitioners to estimate the nature, extent, and magnitude of change in environmental components that may result from project activities. Information about predicted changes is needed for assigning impact significance, prescribing mitigation measures, and designing & developing EMPs and monitoring programs. The more accurate the predictions, the more confident the EIA practitioner will be in prescribing specific measures to eliminate or minimize the adverse impacts of development project.

Choice of models/methods for impact predictions in respect to air, noise, water, land, biological and socio-economic environment are tabulated in **Annexure IX**.

4.4.4 Significance of the impacts

Evaluating the significance of environmental effects is perhaps the most critical component of impact analysis. The interpretation of significance bears directly on the subsequent EIA process and also during prior environmental clearance on project approvals and condition setting. At an early stage, it also enters into screening and scoping decisions on what level of assessment is required and which impacts and issues will be addressed.

Impact significance is also a key to choosing among alternatives. In total, the attribution of significance continues throughout the EIA process, from scoping to EIS review, in a gradually narrowing “cone of resolution” in which one stage sets up the next. But at this stage it is the most important as better understanding and quantification of impact significance is required.

One common approach is based on determination of the significance of predicted changes in the baseline environmental characteristics and compares these w.r.t regulatory standards, objective criteria and similar ‘thresholds’ as eco-sensitivity, cultural /religious values. Often, these are outlined in guidance. A better test proposed by the CEAA (1995) is to determine if ‘residual’ environmental effects are adverse, significant, and likely (given under). But at this stage, the practice of formally evaluating significance of residual impacts, *i.e.*, after predicting the nature and magnitude of impacts based on before-versus-after-project comparisons, and identifying measures to mitigate these effects is not being followed in a systematic way.

i. Step 1: Are the environmental effects adverse?

Criteria for determining if effects are “adverse” include:

- effects on biota health
- effects on rare or endangered species
- reductions in species diversity
- habitat loss
- transformation of natural landscapes
- effects on human health
- effects on current use of lands and resources for traditional purposes by aboriginal persons
- foreclosure of future resource use or production

ii. Step 2: Are the adverse environmental effects significant?

Criteria for determining ‘significance’ are to judge that the impacts:

- are extensive over space or time
- are intensive in concentration or proportion to assimilative capacity
- exceed environmental standards or thresholds
- do not comply with environmental policies, landuse plans, sustainability strategy
- adversely and seriously affect ecologically sensitive areas
- adversely and seriously affect heritage resources, other landuses, community lifestyle and/or indigenous peoples traditions and values

iii. Step 3: Are the significant adverse environmental effects likely?

Criteria for determining ‘likelihood’ include:

- probability of occurrence, and
- scientific uncertainty

4.5 Social Impact Assessment

Social Impact Assessment (SIA) is an instrument used to analyze social issues and solicit stakeholder views for the design of projects. SIA helps in making the project responsive to social development concerns, including options that enhance benefits for poor and vulnerable people while mitigating risk and adverse impacts. It analyzes distributional impacts of intended project benefits on different stakeholder groups, and identifies differences in assets and capabilities to access the project benefits.

The scope and depth of SIA should be determined by the complexity and importance of the issues studied, taking into account the skills and resources available. SIA should include studies related to involuntary resettlement, compulsory land acquisition, impact of imported workforces, job losses among local people, damage to sites of cultural, historic or scientific interest, impact on minority or vulnerable groups, child or bonded labour, use of armed security guards. However, SIA may primarily include the following:

Description of the socio-economic, cultural and institutional profile

Conduct a rapid review of available sources of information to describe the socio-economic, cultural and institutional interface in which the project operates.

Socio-economic and cultural profile: Describe the most significant social, economic and cultural features that differentiate social groups in the project area. Describe their different interests in the project, and their levels of influence. Explain specific effects that the project may have on the poor and underprivileged. Identify any known conflicts among groups that may affect project implementation.

Institutional profile: Describe the institutional environment; consider both the presence and function of public, private and civil society institutions relevant to the operation. Are there important constraints within existing institutions *e.g.* disconnect between institutional responsibilities and the interests and behaviors of personnel within those institutions? Or are there opportunities to utilize the potential of existing institutions, *e.g.* private or civil society institutions, to strengthen implementation capacity.

Legislative and regulatory considerations

To review laws and regulations governing the project's implementation and access of poor and excluded groups to goods, services and opportunities provided by the project. In addition, review the enabling environment for public participation and development planning. SIA should build on strong aspects of legal and regulatory systems to facilitate program implementation and identify weak aspects while recommending alternative arrangements.

Key social issues

SIA provides baseline information for designing the social development strategy. The analysis should determine the key social and Institutional issues which affect the project objectives; identify the key stakeholder groups in this context and determine how relationships between stakeholder groups will affect or be affected by the project; and identify expected social development outcomes and actions proposed to achieve those outcomes.

Data collection and methodology

Describe the design and methodology for social analysis. In this regard:

- Build on existing data;
- Clarify the units of analysis for social assessment: intra-household, household level, as well as communities/settlements and other relevant social aggregations on which data is available or will be collected for analysis;
- Choose appropriate data collection and analytical tools and methods, employing mixed methods wherever possible; mixed methods include a mix of quantitative and qualitative methods.

Strategy to achieve social development outcomes

Identify the likely social development outcomes of the project and propose a social development strategy, including recommendations for institutional arrangements to achieve them, based on the findings of the social assessment. The social development strategy could include measures that:

- strengthen social inclusion by ensuring inclusion of both poor and excluded groups and intended beneficiaries are included in the benefit stream; offer access to opportunities created by the project
- empower stakeholders through their participation in design and implementation of the project, their access to information, and their increased voice and accountability (*i.e.* a participation framework); and
- enhance security by minimizing and managing likely social risks and increasing the resilience of intended beneficiaries and affected persons to socioeconomic shocks

Implications for analysis of alternatives

Review proposed approaches for the project, and compare them in terms of their relative impacts and social development outcomes. Consider what implications the findings of the social assessment might have on those approaches. Should some new components be added to the approach, or other components be reconsidered or modified?

If SIA and consultation processes indicate that alternative approaches may have better development outcomes, such alternatives should be described and considered, along with the likely budgetary and administrative effects these changes might have.

Recommendations for project design and implementation arrangements

Provide guidance to project management and other stakeholders on how to integrate social development issues into project design and implementation arrangements. As much as possible, suggest specific action plans or implementation mechanisms to address relevant social issues and potential impacts. These can be developed as integrated or separate action plans, for example, as Resettlement Action Plans, Indigenous Peoples Development Plans, Community Development Plans, *etc.*

Developing a monitoring plan

Through SIA process, a framework for monitoring and evaluation should be developed. To the extent possible, this should be done in consultation with key stakeholders, especially beneficiaries and affected people.

The framework shall identify expected social development indicators, establish benchmarks, and design systems and mechanisms for measuring progress and results related to social development objectives. The framework shall identify organizational responsibilities in terms of monitoring, supervision, and evaluation procedures. Wherever possible, participatory monitoring mechanisms shall be incorporated. The framework should establish:

- a set of monitoring indicators to track the progress achieved. The benchmarks and indicators should be limited in number, and should combine both quantitative and qualitative types of data. The indicators for outputs to be achieved by the social development strategy should include indicators to monitor the process of stakeholder participation, implementation and institutional reform
- indicators to monitor social risk and social development outcomes; and indicators to monitor impacts of the project's social development strategy. It is important to suggest mechanisms through which lessons learnt from monitoring and stakeholder feedback can result in changes to improve the operation of the project. Indicators should be of such a nature that results and impacts can be disaggregated by gender and other relevant social groups
- define transparent evaluation procedures. Depending on context, these may include a combination of methods, such as participant observation, key informant interviews, focus group discussions, census and socio-economic surveys, gender analysis, Participatory Rural Appraisal (PRA), Participatory Poverty Assessment (PPA) methodologies, and other tools. Such procedures should be tailored to the special conditions of the project and to the different groups living in the project area; Estimate resource and budget requirements for monitoring and evaluation activities, and a description of other inputs (such as institutional strengthening and capacity building) needs to be carried out

4.6 Risk Assessment

Industrial accidents results in great personal and financial loss. Managing these accidental risks in today's environment is the concern of every industry including

induction and electric arc furnace, submerged arc furnace and cupola industry, because either real or perceived incidents can quickly jeopardize the financial viability of a business. Many facilities involve various manufacturing processes that have the potential for accidents which may be catastrophic to the plant, work force, environment, or public.

The main objective of risk assessment study is to propose a comprehensive but simple approach to carry out risk analysis and conducting feasibility studies for industries, planning and management of industrial prototype hazard analysis study in Indian context.

Risk analysis and risk assessment should provide details on Quantitative Risk Assessment (QRA) techniques used world-over to determine risk posed to people who work inside or live near hazardous facilities, and to aid in preparing effective emergency response plans by delineating a Disaster Management Plan (DMP) to handle onsite and offsite emergencies. Hence, QRA is an invaluable method for making informed risk-based process safety and environmental impact planning decisions, as well as being fundamental to any decision while siting a facility. QRA whether, site-specific or risk-specific for any plant is complex and needs extensive study that involves process understanding, hazard identification, consequence modeling, probability data, vulnerability models/data, local weather and terrain conditions and local population data. QRA may be carried out to serve the following objectives:

- Identification of safety areas
- Identification of hazard sources
- Generation of accidental release scenarios for escape of hazardous materials from the facility
- Identification of vulnerable units with recourse to hazard indices
- Estimation of damage distances for the accidental release scenarios with recourse to Maximum Credible Accident (MCA) analysis
- Hazard and Operability studies (HAZOP) in order to identify potential failure cases of significant consequences
- Estimation of probability of occurrences of hazardous event through fault tree analysis and computation of reliability of various control paths
- Assessment of risk on basis of above evaluation against the risk acceptability criteria relevant to the situation
- Suggest risk mitigation measures based on engineering judgement, reliability and risk analysis approaches
- Delineation / upgradation of DMP
- Safety Reports: with external safety report/ occupational safety report

The risk assessment report may cover the following in terms of the extent of damage with resource to MCA analysis and delineation of risk mitigations measures with an approach to DMP.

- Hazard identification – identification of hazardous activities, hazardous materials, past accident records, *etc.*
- Hazard quantification – consequence analysis to assess the impacts
- Risk Presentation
- Risk Mitigation Measures
- Disaster Management Plans

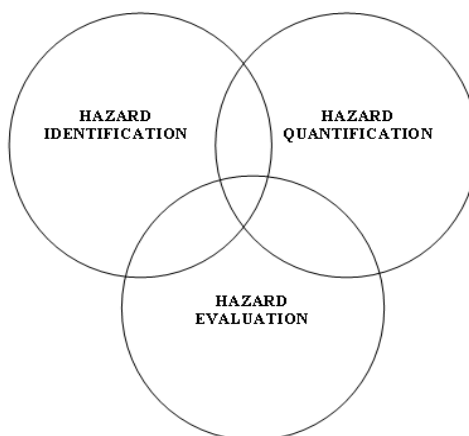

Figure 4-5: Risk Assessment – Conceptual Framework

Methods of risk prediction should cover all the design intentions and operating parameters to quantify risk in terms of probability of occurrence of hazardous events and magnitude of its consequence. Table 4-4 shows the predictive models for risk assessment.

Table 4-4: Choice of Models for Impact Predictions: Risk Assessment

Name	Application	Remarks
EFFECT	Consequence Analysis for Visualization of accidental chemical release scenarios & its consequence	Heat load, press wave & toxic release exposure neutral gas dispersion
WHAZAN	Consequence Analysis for Visualization of accidental chemical release scenarios & its consequence	
DEGADIS	Consequence Analysis for Visualization of accidental chemical release scenarios & its consequence	Dense gas dispersion
HAZOP and Fault Tree Assessment	For estimating top event probability	Failure frequency data is required
Pathways reliability and protective system hazard analysis	For estimating reliability of equipments and protective systems	Markov models
Vulnerability Exposure models	Estimation of population exposure	Uses probit equation for population exposure
F-X and F-N curves	Individual / Societal risks	Graphical Representation

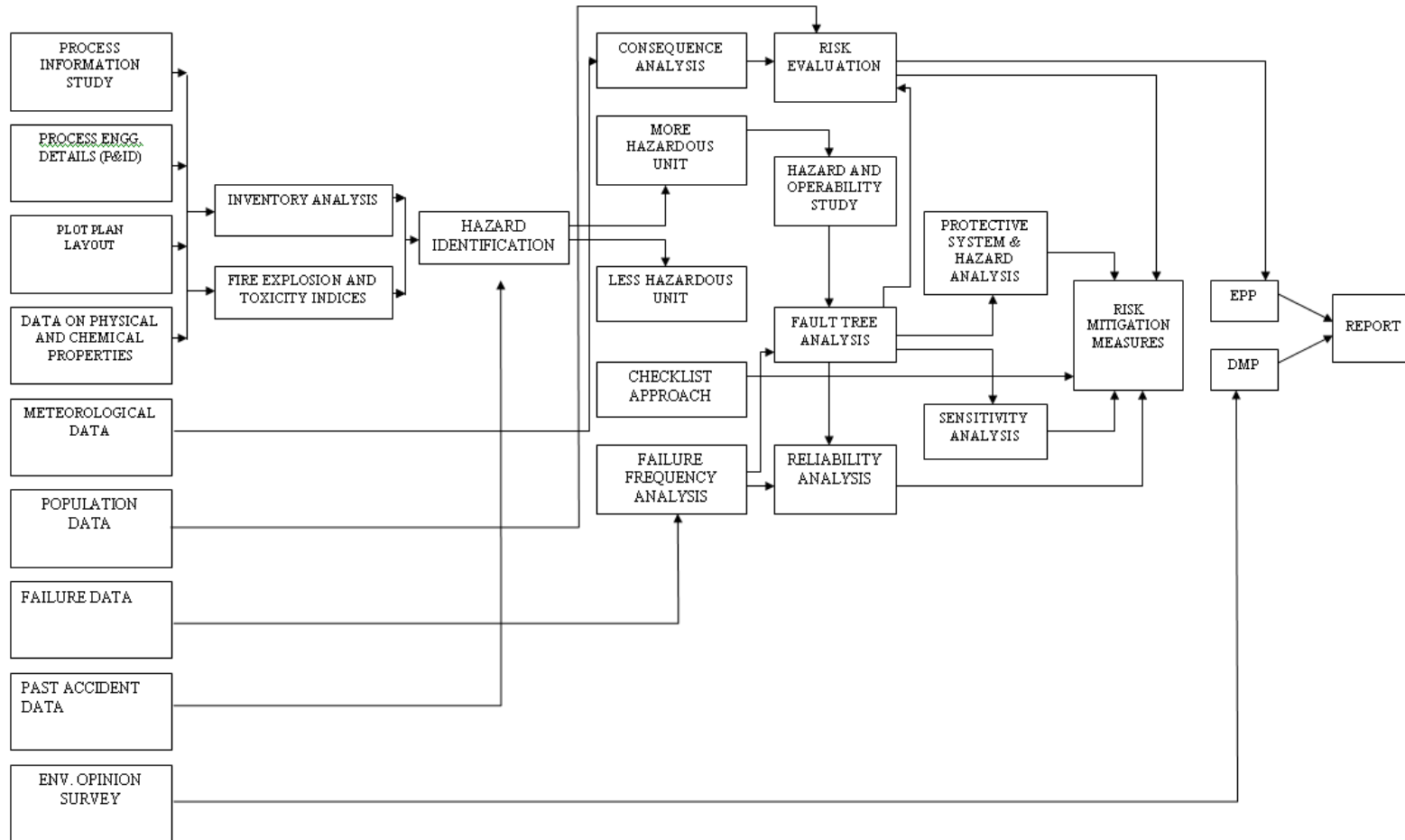

Figure 4-6: Comprehensive Risk Assessment - At a Glance

4.7 Mitigation Measures

The purpose of mitigation is to identify measures that safeguard the environment and the community affected by the proposal. Mitigation is both a creative and practical phase of the EIA process. It seeks to find the best ways and means of avoiding, minimizing and remedying impacts. Mitigation measures must be translated into action in right way and at the right time, if they are to be successful. This process is referred to as impact management and takes place during project implementation. A written plan should be prepared for this purpose, and should include a schedule of agreed actions. Opportunities for impact mitigation will occur throughout the project cycle.

4.7.1 Important considerations for mitigation methods

The responsibility of project proponents to ‘internalize’ the full environmental costs of development proposals is now widely accepted under “Polluter Pay” principle. In addition, many proponents have found that good design and impact management can result in significant savings applying the principles of cleaner production to improve their environmental performance.

- The predicted adverse environmental as well as social impacts for which mitigation measures are required should be identified and briefly summarized along with cross referencing them to the significance, prediction components of the EIA report or other documentation.
- Each mitigation measure should be briefly described w.r.t the impact of significances to which it relates and the conditions under which it is required (for example, continuously or in the event of contingencies). These should also be cross-referenced to the project design and operating procedures which elaborate on the technical aspects of implementing the various measures.
- Cost and responsibilities for mitigation and monitoring should be clearly defined, including arrangements for coordination among various Authorities responsible for mitigation.
- The proponent can use the EMP to develop environmental performance standards and requirements for the project site as well as supply chain. An EMP can be implemented through EMS for the operational phase of the project.

Prior to selecting mitigation plans it is appropriate to study the mitigation alternatives for cost-effectiveness, technical and socio-political feasibility. Such mitigation measures could include:

- avoiding sensitive areas such as eco-sensitive area *e.g.* fish spawning areas, dense mangrove areas or areas known to contain rare or endangered species
- adjusting work schedules to minimize disturbance
- engineered structures such as berms and noise attenuation barriers
- pollution control devices such as scrubbers bag filters, dust suppression systems and electrostatic precipitators
- changes in fuel feed, manufacturing, process, technology use, or waste management practices, *etc.*

4.7.2 Hierarchy of elements of mitigation plan

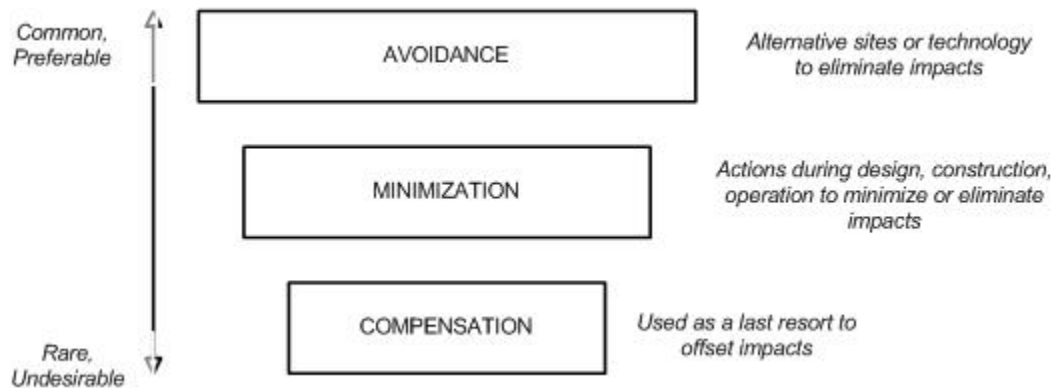

Figure 4-7: Elements of Mitigation

A good EIA practice requires technical understanding of relevant issues and the measures that work in such given circumstances. The priority of selection of mitigation measures should be in the order:

Step One: Impact avoidance

This step is most effective when applied at an early stage of project planning. It can be achieved by:

- not undertaking certain projects or elements that could result in adverse impacts
- avoiding areas that are environmentally sensitive
- putting in place the preventative measures to stop adverse impacts from occurring, for example, release of water from a reservoir to maintain a fisheries regime

Step Two: Impact minimization

This step is usually taken during impact identification and prediction to limit or reduce the degree, extent, magnitude, or duration of adverse impacts. It can be achieved by:

- scaling down or relocating the proposal
- redesigning elements of the project
- taking supplementary measures to manage the impacts

Step Three: Impact compensation

This step is usually applied to remedy unavoidable residual adverse impacts. It can be achieved by:

- rehabilitation of the affected site or environment, for example, by habitat enhancement and restocking fish
- restoration of the affected site or environment to its previous state or better, as typically required for mine sites, forestry roads and seismic lines
- replacement of the same resource values at another location. For example, by wetland engineering to provide an equivalent area to that lost to drainage or infill

Important compensation elements

Resettlement Plans: Special considerations apply to mitigation of proposals that displace or disrupt people. Certain types of projects, such as reservoirs and irrigation schemes and public works, are known to cause involuntary resettlement. This is a contentious issue because it involves far more than re-housing people; in addition, income sources and access to common property resources are likely to be lost. Almost certainly, a resettlement plan will be required to ensure that no one is worse off than before, which may not be possible for indigenous people whose culture and lifestyle is tied to a locality. This plan must include the means for those displaced to reconstruct their economies and communities and should include an EIA of the receiving areas. Particular attention should be given to indigenous, minority and vulnerable groups who are at higher risk from resettlement.

In-kind compensation

When significant or net residual loss or damage to the environment is likely, in kind compensation is appropriate. As noted earlier, environmental rehabilitation, restoration or replacement have become standard practices for many proponents. Now, increasing emphasis is given to a broader range of compensation measures to offset impacts and assure the sustainability of development proposals. These include impact compensation 'trading', such as offsetting CO₂ emissions by planting forests to sequester carbon.

4.7.3 Typical mitigation measures

Choice of location for the developmental activity plays an important role in preventing adverse impacts on surrounding environment. Detailed guidelines on siting of industries are provided in Section 4.2. However, if the developmental activity produces any more adverse impacts, mitigation measures should be taken.

Previous sub-sections of the Section 4.7 could be precisely summarized into following:

- Impacts from a developmental project could have many dimensions. As most of the direct impacts are caused by releases from developmental projects, often control at source is the best opportunity to either eliminate or mitigate the impacts, in case these are cost-effective. In other words, the best way to mitigate impacts is to prevent them from occurring. Choice of raw materials/technologies/processes which produce least impact would be one of the options to achieve it.
- After exploring cost-effective feasible alternatives to control impacts at source, various interventions to minimize adverse impacts may be considered. These interventions, primarily aim at reducing the residual impacts on VECs of the receiving environment to acceptable concentrations.
- Degree of control at source and external interventions differs from situation-to-situation and is largely governed by techno-economic feasibility. While the regulatory bodies stress for further source control (due to high reliability), the project proponents bargain for other interventions which may be relatively cost-effective than further control at source (in any case, project authority is required to meet the industry-specific standards by adopting the best practicable technologies. However, if the location demands further control at source, then the proponents are required to adopt further advanced control technologies, *i.e.* towards best available control technologies). After having discussions with the project proponent, EAC/SEAC

reaches to an agreed level of source control + other interventions (together called as mitigation measures in the given context) that achieve the targeted protection levels for the VECs in the receiving environment. These levels will become the principal clearance conditions.

- Chapter 3 of this TGM offers elaborate information on cleaner technologies, waste minimization opportunities, and control technologies for various kinds of polluting parameters that emanate from this developmental activity. This information may be used to draw appropriate control measures applicable at source.

The choice of interventions for mitigation of impacts may also be numerous and depend on various factors. Mitigation measures based on location-specific suitability and some other factors are discussed in sub-sections 4.7.1 and 4.7.2. A few typical measures which may also be explored for mitigation of impacts are listed in Table 4-5.

Table 4-5: Typical Mitigation Measures

Impacts	Typical Mitigation steps
Soil erosion	<ul style="list-style-type: none"> Windscreens, maintenance, and installation of ground cover Installation of drainage ditches Runoff and retention ponds Minimize disturbances and scarification of the surface Usage of appropriate monitoring and control facilities for construction equipments deployed Methods to reuse earth material generated during excavation, <i>etc.</i>
Resources- fuel/ construction material, <i>etc.</i>	<ul style="list-style-type: none"> Availing the resources which could be replenished by natural systems, <i>etc.</i>
Deforestation	<ul style="list-style-type: none"> Plant or create similar areas Initiate a tree planting program in other areas Donate land to conservationist groups, <i>etc.</i>
Water pollution and issues	<ul style="list-style-type: none"> Channeling and retention of water to reduce erosion and situation Collection and treatment of sewage and organic waste Increased recycling and reuse of water Use of biodegradable or otherwise readily treatable additives Cooling ponds, towers and canals to reduce temperatures of cooling water discharge Neutralization and sedimentation of wastewater Dewatering of sludges and appropriate disposal of solids Use deep well injection below potable levels Construct liners of ponds and solids waste disposal To avoid to dilute water at point of discharge, <i>etc.</i>
Air pollution	<ul style="list-style-type: none"> Periodic checking of vehicles and construction machinery to ensure compliance to emission standards Attenuation of pollution/protection of receptor through green belts/green cover Regular monitoring of air polluting concentrations Wetting of roadways to reduce traffic dust and reentrained particles Installation of windscreens to breakup the wind flow Burning of refuse in incinerators on days when meteorological conditions provide for good mixing and dispersion Proper dust collection and gas cleaning equipment meeting emission limits, <i>etc.</i>

Impacts	Typical Mitigation steps
Ambient Noise pollution	<ul style="list-style-type: none"> ▪ Heavy duty muffler systems on heavy equipment to reduce noise power level to specification ▪ Noise proof enclosures ▪ Plant trees as green belt ▪ Limiting certain activities ▪ Periodic maintenance of equipments/repalcing whenever necessary/lubrication of rotating parts, <i>etc.</i> ▪ Maintain noise levels from below 90 dB(A) ▪ Provide ear protection if in excess ▪ Limit duty hours
Chemical discharges and spills	<ul style="list-style-type: none"> ▪ Develop spill prevention plans ▪ Develop traps and containment system and chemically treat discharges on site, <i>etc.</i>
Worker exposure to dust from ash and coal	<ul style="list-style-type: none"> ▪ Provide dust extraction equipment ▪ Maintain dust levels less than 10 mg/m³ or as stipulated by Factories Act. ▪ Monitor for free silica content ▪ Provide dust masks when levels are exceeded, <i>etc.</i>
Worker exposure to toxic gases leaking from the plant	<ul style="list-style-type: none"> ▪ Maintain plant properly ▪ Monitor concentrations of pollutants with levels not to exceed TWA 8 hrs. threshold levels as stipulated by Factories Act, <i>e.g.</i>, ▪ SO₂ – 2 ppm ▪ CO – 50 ppm ▪ NO₂ – 3 ppm
Induced secondary development puts increased demand on infrastructure	<ul style="list-style-type: none"> ▪ Provide infrastructure plan and financial support for increased demands ▪ Construct facilities to reduce demands
Occupational health and safety	<ul style="list-style-type: none"> ▪ Provision of worker camps with proper sanitation and medical facilities, as well as making the worker camps self- sufficient with resources like water supply, power supply, <i>etc.</i> ▪ Arrangement of periodic health check-ups for early detection and control of communicatble diseases. ▪ Arrangement to dispose off the wastes at approved disposal sites. ▪ Provide preventive measures for potential fire hazards with requisite fire detection, fire-fighting facilities and adequate water storage, <i>etc.</i>
Social	<ul style="list-style-type: none"> ▪ Health and safety measures for workers ▪ Development of traffic plan that minimizes road use by workers ▪ Upgrade of roads and intersections ▪ Provide sufficient counselling and time to the affected population for relocation ▪ Discuss and finalize alternate arrangements and associated infrastructure in places of religious importance ▪ Exploration of alternative approach routes in consultation with local community and other stakeholders ▪ Provision of alternate jobs in unskilled and skilled categories

4.8 Environmental Management Plan

A typical EMP shall be composed of the following:

1. summary of potential impacts of the proposal
2. description of recommended mitigation measures
3. description of monitoring programme to ensure compliance with relevant standards and residual impacts
4. allocation of resources and responsibilities for plan implementation
5. implementation schedule and reporting procedures
6. contingency plan when impacts are greater than expected

Summary of impacts: The predicted adverse environmental and social impacts for which mitigation measures are identified in earlier sections to be briefly summarized with cross referencing to the corresponding sections in EIA report.

Description of mitigation measures: Each mitigation measure should be briefly described w.r.t. the impact to which it relates and the conditions under which it is required. These should be accompanied by/referenced to, project design and operating procedures which elaborate on the technical aspects of implementing various measures.

Description of monitoring programme to ensure compliance with relevant standards and residual impacts: Environmental monitoring refers to compliance monitoring and residual impact monitoring. Compliance monitoring refers to meeting the industry-specific statutory compliance requirements (Ref. Applicable National regulations as detailed in Chapter 3).

Residual impact monitoring refers to monitoring of identified sensitive locations with adequate number of samples and frequency. The monitoring programme should clearly indicate the linkages between impacts identified in the EIA report, measurement indicators, detection limits (where appropriate), and definition of thresholds that signal the need for corrective actions.

Allocation of resources and responsibilities for plan implementation: These should be specified for both the initial investment and recurring expenses for implementing all measures contained in the EMP, integrated into the total project costs, and factored into loan negotiation.

The EMP should contain commitments that are binding on the proponent in different phases of project implementation *i.e.*, pre-construction or site clearance, construction, operation, decommissioning.

Responsibilities for mitigation and monitoring should be clearly defined, including arrangements for coordination between various actors responsible for mitigation. Details should be provided w.r.t deployment of staff (detailed organogram), monitoring network design, parameters to be monitored, analysis methods, associated equipments, *etc.*

Implementation schedule and reporting procedures: The timing, frequency and duration of mitigation measure should be specified in an implementation schedule, showing links with overall project implementation. Procedures to provide information on

progress and results of mitigation and monitoring measures should also be clearly specified.

Contingency Plan when the impacts are greater than expected: There shall be a contingency plan for attending the situations where the residual impacts are higher than expected. It is an imperative requirement for all project Authorities to plan additional programmes to deal with the situation, after duly intimating the concerned local regulatory bodies.

4.9 Reporting

Structure of the EIA report (Appendix III of the EIA Notification), applicable for induction and electric arc furnace, submerged arc furnace and cupola industry is given in the Table 4.6. Each task prescribed in ToR shall be incorporated appropriately in the contents in addition to the contents described in the table.

Table 4-6: Structure of EIA Report

S.NO	EIA STRUCTURE	CONTENTS
1.	Introduction	<ul style="list-style-type: none"> ▪ Purpose of the report ▪ Identification of project & project proponent ▪ Brief description of nature, size, location of the project and its importance to the country, region ▪ Scope of the study – details of regulatory scoping carried out (As per Terms of Reference)
2.	Project Description	<p>Condensed description of those aspects of the project (based on project feasibility study), likely to cause environmental effects. Details should be provided to give clear picture of the following:</p> <ul style="list-style-type: none"> ▪ Type of project ▪ Need for the project ▪ Location (maps showing general location, specific location, project boundary & project site layout) ▪ Size or magnitude of operation (incl. Associated activities required by or for the project) ▪ Proposed schedule for approval and implementation ▪ Technology and process description ▪ Project description including drawings showing project layout, components of project <i>etc.</i> Schematic representations of the feasibility drawings which give information important for EIA purpose ▪ Description of mitigation measures incorporated into the project to meet environmental standards, environmental operating conditions, or other EIA requirements (as required by the scope) ▪ Assessment of new & untested technology for the risk of technological failure
3.	Description of the Environment	<ul style="list-style-type: none"> ▪ Study area, period, components & methodology ▪ Establishment of baseline for VECs, as identified in the scope ▪ Base maps of all environmental components
4.	Anticipated Environmental Impacts &	<ul style="list-style-type: none"> ▪ Details of Investigated Environmental impacts due to project location, possible accidents, project design, project construction, regular operations, final decommissioning or

S.NO	EIA STRUCTURE	CONTENTS
	Mitigation Measures	rehabilitation of a completed project <ul style="list-style-type: none"> ▪ Measures for minimizing and / or offsetting adverse impacts identified ▪ Irreversible and irretrievable commitments of environmental components ▪ Assessment of significance of impacts (Criteria for determining significance, Assigning significance) ▪ Mitigation measures
5.	Analysis of Alternatives (Technology & Site)	In case, the scoping exercise results in need for alternatives: <ul style="list-style-type: none"> ▪ Description of each alternative ▪ Summary of adverse impacts of each alternative ▪ Mitigation measures proposed for each alternative and selection of alternative
6.	Environmental Monitoring Program	<ul style="list-style-type: none"> ▪ Technical aspects of monitoring the effectiveness of mitigation measures (incl. measurement methodologies, frequency, location, data analysis, reporting schedules, emergency procedures, detailed budget & procurement schedules)
7.	Additional Studies	<ul style="list-style-type: none"> ▪ Public consultation ▪ Risk assessment ▪ Social impact assessment, R&R action plans
8.	Project Benefits	<ul style="list-style-type: none"> ▪ Improvements in physical infrastructure ▪ Improvements in social infrastructure ▪ Employment potential –skilled; semi-skilled and unskilled ▪ Other tangible benefits
9.	Environmental Cost Benefit Analysis	<ul style="list-style-type: none"> ▪ If recommended at the scoping stage
10.	EMP	<ul style="list-style-type: none"> ▪ Description of the administrative aspects that ensures proper implementation of mitigative measures are implemented and their effectiveness monitored, after approval of the EIA
11.	Summary & Conclusion (This will constitute the summary of the EIA Report)	<ul style="list-style-type: none"> ▪ Overall justification for implementation of the project ▪ Explanation of how, adverse effects have been mitigated
12.	Disclosure of Consultants engaged	<ul style="list-style-type: none"> ▪ Names of the Consultants engaged with their brief resume and nature of Consultancy rendered

4.10 Public Consultation

Public consultation refers to the process by which the concerns of local affected people and others who have plausible stake in the environmental impacts of the project or activity are ascertained.

- Public consultation is not a decision taking process, but is a process to collect views of the people having plausible stake. If the SPCB/Public agency conducting public hearing is not convinced with the plausible stake, then such expressed views need not be considered.

Operational Aspects of EIA

- Public consultation involves two components, one is public hearing, and other one is inviting written responses/objections through Internet/by post, *etc.*, by placing the summary of EIA report on the web site.
- All Category A and Category B1 projects require public hearing except the following:
 - Once prior environmental clearance is granted to industrial estates/SEZs/EPZs *etc.*, for a given composition (type and capacity) of industries, then individual units will not require public hearing
 - Expansion of roads and highways, which do not involve any further acquisition of land.
 - Maintenance dredging provided the dredged material shall be disposed within port limits
 - All building/ construction projects/ area development projects/townships
 - All Category B2 projects
 - All projects concerning national defense and security or involving other strategic considerations as determined by the Central Government
- Public hearing shall be carried out at the site or in its close proximity, district-wise, for ascertaining concerns of local affected people.
- Project proponent shall make a request through a simple letter to the Member–Secretary of the SPCB/UTPCC to arrange public hearing.
- Project proponent shall enclose with the letter of request, at least 10 hard copies and 10 soft copies of the draft EIA report including the summary EIA report in English and in official language of the state/local language prepared as per the approved scope of work, to the concerned Authority.
- Simultaneously, project proponent shall arrange to send, one hard copy and one soft copy, of the above draft EIA report along with the summary EIA report to the following Authorities within whose jurisdiction the project will be located:
 - District magistrate/District Collector/Deputy Commissioner (s)
 - Zilla parishad and municipal corporation or panchayats union
 - District industries office
 - Urban local bodies (ULBs)/PRIs concerned/development authorities
 - Concerned regional office of the MoEF/SPCB
- Above mentioned Authorities except regional office of MoEF shall arrange to widely publicize the draft EIA report within their respective jurisdictions requesting the interested persons to send their comments to the concerned regulatory Authorities. They shall also make draft EIA report for inspection electronically or otherwise to the public during normal office hours till the public hearing is over.
- Concerned regulatory Authority (MoEF/SEIAA/UTEIA) shall display the summary of EIA report on its website and also make full draft EIA report available for reference at a notified place during normal office hours at their head office.
- SPCB or UTPCC concerned shall also make similar arrangements for giving publicity about the project within the State/UT and make available the summary of draft EIA report for inspection in select offices, public libraries or any other suitable location, *etc.* They shall also additionally make available a copy of the draft EIA report to the above five authorities/offices as mentioned above.
- The Member–Secretary of the concerned SPCB or UTPCC shall finalize the date, time and exact venue for the conduct of public hearing within seven days of the date of the receipt of the draft EIA report from the project proponent and advertise the

same in one major National Daily and one Regional vernacular Daily/Official State Language.

- A minimum notice period of 30 (thirty) days shall be provided to the public for furnishing their responses.
- No postponement of the date, time, venue of the public hearing shall be undertaken, unless some untoward emergency situation occurs. Only in case of emergencies and up on recommendation of the concerned District Magistrate/District Collector/Deputy Commissioner, the postponement shall be notified to the public through the same National and Regional vernacular dailies and also prominently displayed at all the identified offices by the concerned SPCB/ UTPCC
- In the above exceptional circumstances fresh date, time and venue for the public consultation shall be decided by the Member–Secretary of the concerned SPCB/ UTPCC only in consultation with the District Magistrate/District Collector/Deputy Commissioner and notified afresh as per the procedure.
- The District Magistrate/District Collector/Deputy Commissioner or his or her representative not below the rank of an Additional District Magistrate assisted by a representative of SPCB or UTPCC, shall supervise and preside over the entire public hearing process.
- The SPCB/UTPCC shall arrange to video film the entire proceedings. A copy of the videotape or a CD shall be enclosed with the public hearing proceedings while forwarding it to the Regulatory Authority concerned.
- The attendance of all those who are present at the venue shall be noted and annexed with the final proceedings
- There shall be *no quorum* required for attendance for starting the proceedings
- Persons present at the venue shall be granted the opportunity to seek information or clarifications on the project from the Proponent. The summary of the public hearing proceedings accurately reflecting all the views and concerns expressed shall be recorded by the representative of the SPCB/UTPCC and read over to the audience at the end of the proceedings explaining the contents in the local/vernacular language and the agreed minutes shall be signed by the District Magistrate/District Collector/Deputy Commissioner or his or her representative on the same day and forwarded to the SPCB/UTPCC concerned.
- A statement of the issues raised by the public and the comments of the proponent shall also be prepared in the local language or the official State language, as the case may be and in English and annexed to the proceedings.
- The proceedings of the public hearing shall be conspicuously displayed at the office of the Panchayats within whose jurisdiction the project is located, office of the concerned Zilla Parishad, District Magistrate/District Collector/Deputy Commissioner, and the SPCB or UTPCC. The SPCB/UTPCC shall also display the proceedings on its website for general information. Comments, if any, on the proceedings, may be sent directly to the concerned regulatory authorities and the Applicant concerned.
- The public hearing shall be completed within a period of 45 (forty five) days from date of receipt of the request letter from the Applicant. Therefore the SPCB or UTPCC concerned shall send public hearing proceedings to the concerned regulatory authority within eight (8) days of the completion of the public hearing. Simultaneously, a copy will also be provided to the project proponent. The proponent may also directly forward a copy of the approved public hearing proceedings to the

regulatory authority concerned along with the final EIA report or supplementary report to the draft EIA report prepared after the public hearing and public consultations incorporating the concerns expressed in the public hearing along with action plan and financial allocation, item-wise, to address those concerns.

- Upon receipt of the same, the Authority will place executive summary of the report on the website to invite responses from other concerned persons having a plausible stake in the environmental aspects of the project or activity.
- If SPCB/UTPCC is unable to conduct public hearing in the prescribed time, the Central Government in case of Category A projects and State Government or UT administration in case of Category B projects at the request of the SEIAA may engage any other agency or Authority for conducting the public hearing process within a further period of 45 days. The respective governments shall pay the appropriate fee to the public agency for conducting public hearing.
- A public agency means a non-profit making institution/ body such as technical/academic institutions, government bodies not subordinate to the concerned Authority.
- If SPCB/Public Agency authorized for conducting public hearing informs the Authority, stating that it is not possible to conduct the public hearing in a manner, which will enable the views of the concerned local persons to be freely expressed, then Authority may consider such report to take a decision that in such particular case, public consultation may not have the component of public hearing.
- Often restricting the public hearing to the specific district may not serve the entire purpose, therefore, NGOs who are local and registered under the Societies Act in the adjacent districts may also be allowed to participate in public hearing, if they so desire.
- Confidential information including non-disclosable or legally privileged information involving intellectual property right, source specified in the application shall not be placed on the website.
- The Authority shall make available on a written request from any concerned person the draft EIA report for inspection at a notified place during normal office hours till the date of the public hearing.
- While mandatory requirements will have to be adhered to, utmost attention shall be given to the issues raised in the public hearing for determining the modifications needed in the project proposal and the EMP to address such issues.
- Final EIA report after making needed amendments, as aforesaid, shall be submitted by the applicant to the concerned Authority for prior environmental clearance. Alternatively, a supplementary report to draft EIA and EMP addressing all concerns expressed during the public consultation may be submitted.

4.11 Appraisal

Appraisal means the detailed scrutiny by the EAC/SEAC of the application and the other documents like the final EIA report, outcome of the public consultation including public hearing proceedings submitted by the applicant for grant of prior environmental clearance.

- The appraisal shall be made by EAC to the Central Government or SEAC to SEIAA.

Operational Aspects of EIA

- Project proponent either personally or through consultant can make a presentation to EAC/SEAC for the purpose of appraising the features of the project proposal and also to clarify the issues raised by the members of the EAC/SEAC.
- On completion of these proceedings, concerned EAC/SEAC shall make categorical recommendations to the respective Authority, either for grant of prior environmental clearance on stipulated terms & conditions, if any, or rejection of the application with reasons.
- In case EAC/SEAC needs to visit the site or obtain further information before being able to make categorical recommendations, EAC/SEAC may inform the project proponent accordingly. In such an event, it should be ensured that the process of prior environmental clearance is not unduly delayed to go beyond the prescribed timeframe.
- Up on the scrutiny of the final report, if EAC/SEAC opines that ToR for EIA studies finalized at the scoping stage are covered by the proponent, then the project proponent may be asked to provide such information. If such information is declined by the project proponent or is unlikely to be provided early enough so as to complete the environmental appraisal within prescribed time of 60 days, the EAC/SEAC may recommend for rejection of the proposal with the same reason.
- Appraisal shall be strictly in terms of ToR for EIA studies finalized at the scoping stage and the concerns expressed during public consultation.
- This process of appraisal shall be completed within 60 days from the receipt of the updated EIA and EMP reports, after completing public consultation.
- The EIA report will be typically examined for following:
 - Project site description supported by topographic maps & photographs – detailed description of topography, land use and activities at the proposed project site and its surroundings (buffer zone) supported by photographic evidence.
 - Clarity in description of drainage pattern, location of eco-sensitive areas, vegetation characteristics, wildlife status - highlighting significant environmental attributes such as feeding, breeding and nesting grounds of wildlife species, migratory corridor, wetland, erosion and neighboring issues.
 - Description of the project site – how well the interfaces between the project related activities and the environment have been identified for the entire project cycle *i.e.* construction, operation and decommissioning at the end of the project life.
 - If it is envisaged that the project is to be closed after a specified period in case of mining projects, the interface at the closure stage also needs to be described.
 - How complete and authentic are the baseline data pertaining to flora and fauna and socio-economic aspects?
 - Citing of proper references, with regard to the source(s) of baseline data as well as the name of the investigators/investigating agency responsible for collecting the primary data.
 - How consistent are the various values of environmental parameters with respect to each other?
 - Is a reasonable assessment of the environmental and social impact made for the identified environmental issues including project affected people?

- To what extent the proposed environmental plan will mitigate the environmental impact and at what estimated cost, shown separately for construction, operation and closure stages and also separately in terms of capital and recurring expenses along with details of agencies that will be responsible for the implementation of environmental plan/ conservation plan.
- How well the concerns expressed/highlighted during public hearing have been addressed and incorporated in the EMP giving item wise financial provisions and commitments (in quantified terms)?
- How far the proposed environmental monitoring plan will effectively evaluate the performance of EMP? Are details for environmental monitoring plan provided in the same manner as the EMP?
- Identification of hazard and quantification of risk assessment and whether appropriate mitigation plan has been included in the EMP?
- Does the proposal include a well formulated time bound green belt development plan for mitigating environmental problems such as fugitive emission of dust, gaseous pollutants, noise, odour, *etc.*
- Does EIA make a serious attempt to guide the project proponent for minimizing the requirement of natural resources including land, water energy and other non renewable resources?
- How well has the EIA statement been organized and presented so that the issues, their impact and environmental management strategies emerge clearly from it and how well organized was the power point presentation made before the expert committee?
- Is the information presented in the EIA adequately and appropriately supported by maps, imageries and photographs highlighting site features and environmental attributes?

4.12 Decision Making

The Chairperson reads the sense of the Committee and finalizes the draft minutes of the meeting, which are circulated by the Secretary to all expert members invited to the meeting. Based on the response from the members, the minutes are finalized and signed by the Chairperson. This process for finalization of the minutes should be so organized that the time prescribed for various stages is not exceeded.

Approval / Rejection / Reconsideration

- The Authority shall consider the recommendations of concerned appraisal Committee and convey its decision within 45 days of the receipt of recommendations.
- If the Authority disagrees with the recommendations of the Appraisal Committee, then reasons shall be communicated to concerned Appraisal Committee and applicant within 45 days from the receipt of the recommendations. The Appraisal Committee concerned shall consider the observations of the Authority and furnish its views on the observations within further period of 60 days. The Authority shall take a decision within the next 30 days based on the views of appraisal Committee.
- If the decision of the Authority is not conveyed within the time, then the proponent may proceed as if the prior environmental clearance sought has been granted or denied by the regulatory authority in terms of the final recommendation of the

concerned appraisal Committee. For this purpose, the decision of the Appraisal Committee will be a public document, once the period specified above for taking the decision by the Authority is over.

- In case of Category B projects, application shall be received by the Member–Secretary of the SEIAA and clearance shall also be issued by the same SEIAA.
- Deliberate concealment and/or submission of false or misleading information or data which is material to screening or scoping or appraisal or decision on the application shall make the application liable for rejection, and cancellation of prior environmental clearance granted on that basis. Rejection of an application or cancellation of a prior environmental clearance already granted, on such ground, shall be decided by the regulatory authority, after giving a personal hearing to the applicant, and following the principles of natural justice.

If approved

- MoEF or concerned SEIAA will issue the environmental clearance for the project.
- The project proponent should make sure that the award of prior environmental clearance is properly publicized in at least two local newspapers of the district or state where the proposed project is located. For instance, the executive summary of the prior environmental clearance may be published in the newspaper along with the information about the location (website/office where it is displayed for public) where the detailed prior environmental clearance is made available. The MoEF and SEIAA/UTEIAA, as the case may be, shall also place the prior environmental clearance in the public domain on Government Portal. Further copies of the prior environmental clearance shall be endorsed to the Heads of local bodies, Panchayats and Municipal bodies in addition to the relevant offices of the Government.
- The prior environmental clearance will be valid from the start date to actual commencement of the production of the developmental activity.
- Usual validity period will be 5 years from the date of issuing environmental clearance, unless specified by EAC/SEAC.
- A prior environmental clearance issued to a project proponent can be transferred to another legal person entitled to undertake the project, upon application by the transferor to the concerned Authority or submission of no-objection of the transferor by the transferee to the concerned Authority for the concurrence. In this case, EAC/SEAC concurrence is not required, but approval from the concerned authority is required to avail the same project configurations, validity period transferred to the new legally entitled person to undertake the project.

4.13 Post-clearance Monitoring Protocol

The MoEF, Government of India will monitor and take appropriate action under the EP Act, 1986.

- In respect of Category A projects, it shall be mandatory for the project proponent to make public the environmental clearance granted for their project along with the environmental conditions and safeguards at their cost by advertising it at least in two local newspapers of the district or State where the project is located and in addition, this shall also be displayed in the project proponents website permanently.

Operational Aspects of EIA

- In respect of Category B projects, irrespective of its clearance by MoEF/SEIAA, the project proponent shall prominently advertise in the newspapers indicating that the project has been accorded environment clearance and the details of MoEF website where it is displayed.
- The MoEF and the SEIAAs/UTEIAAs, as the case may be, shall also place the environmental clearance in the public domain on Government Portal.
- Copies of environmental clearance shall be submitted by the project proponents to the Heads of the local bodies, Panchayats and Municipal bodies in addition to the relevant offices of the Government who in turn have to display the same for 30 days from the date of receipt.

The project proponent must submit half-yearly compliance reports in respect of the stipulated prior environmental clearance terms and conditions in hard and soft copies to the regulatory authority concerned, on 1st June and 1st December of each calendar year.

All such compliance reports submitted by the project management shall be public documents. Copies of the same shall be given to any person on application to the concerned regulatory authority. Such latest compliance report shall also be displayed on the website of the concerned regulatory Authority

The SPCB shall incorporate EIA clearance conditions into consent conditions in respect of Category A and Category B projects and in parallel shall monitor and enforce the same.

5.

STAKEHOLDERS' ROLES AND RESPONSIBILITIES

Prior environmental clearance process involves many stakeholders *i.e.*, Central Government, State Government, SEIAA, EAC at the National Level, SEAC, Public Agency, SPCB, the project proponent, and the public.

- Roles and responsibilities of the organizations involved in different stages of prior environmental clearance are listed in Table 5-1.
- Organization-specific functions are listed in Table 5-2.

In this Chapter, constitution, composition, functions, *etc.*, of the Authorities and the Committees are discussed in detail.

Table 5-1: Roles and Responsibilities of Stakeholders Involved in Prior Environmental Clearance

Stage	MoEF/ SEIAA	EAC/ SEAC	Project Proponent	EIA Consultant	SPCB/ Public Agency	Public And Interest Group
Screening	Receives application and takes advice of EAC/ SEAC	Advises the MoEF/ SEIAA	Submits application (Form 1) and provides necessary information	Advises and assists the proponent by providing technical information		
Scoping	Approves the ToR, communicates the same to the project proponent and places the same in the website	Reviews the ToR, visits the proposed site, if required and recommends the ToR to the MoEF/ SEIAA	Submits the draft ToR to SEIAA and facilitates the visit of the EAC/SEAC members to the project site	Prepares ToR		
EIA Report & Public Hearing	Reviews and forwards copies of the EIA report to SPCB /public agency for conducting public hearing Places the summary		Submits detailed EIA report as per the finalized ToR Facilitates the public hearing by arranging presentation on the project, EIA and EMP – takes note of objections and updates the	Prepares the EIA report Presents and appraises the likely impacts and pollution control measures proposed in the public hearing	Reviews EIA report and conducts public hearing in the manner prescribed Submits proceedings and views of SPCB, to the Authority	Participates in public hearings and offers comments and observations Comments can be sent directly to SEIAA through Internet in

Stakeholders' Roles and Responsibilities

Stage	MoEF/SEIAA	EAC/SEAC	Project Proponent	EIA Consultant	SPCB/ Public Agency	Public And Interest Group
	of EIA report in the website Conveys objections to the project proponent for update, if any		EMP accordingly		and the project proponent as well	response to the summary placed in the website
Appraisal and Clearance	Receives updated EIA Takes advice of EAC/SEAC, approves EIA and attaches the terms and conditions	Critically examines the reports, presentation of the proponent and appraises MoEF/SEIAA (recommendations are forwarded to MoEF/SEIAA)	Submits updated EIA, EMP reports to MoEF/SEIAA. Presents the overall EIA and EMP including public concerns to EAC/SEAC	Provides technical advise to the project proponent and if necessary presents the proposed measures for mitigation of likely impacts (terms and conditions of clearance)		
Post-clearance Monitoring			Implements environmental protection measures prescribed and submits periodic monitoring results	Conducts periodic monitoring	Incorporates the clearance conditions into appropriate consent conditions and ensures implementation	

Table 5-2: Organization-specific Functions

Organization	Functions
Central Government	<ul style="list-style-type: none"> ▪ Constitutes the EAC ▪ Considering recommendations of the State Government, constitutes the SEIAA & SEAC ▪ Receives application from the project proponent in case of Category A projects or Category B projects attracting general condition ▪ Communicates the ToR finalized by the EAC to the project proponent. ▪ Receives EIA report from the project proponent and soft copy of summary of the report for placing in the website ▪ Summary of EIA report will be placed in website. Forwards the received responses to the project proponent ▪ Engages other public agency for conducting public hearings in cases where the SPCB does not respond within time

Stakeholders' Roles and Responsibilities

Organization	Functions
	<ul style="list-style-type: none"> ▪ Receives updated EIA report from project proponent incorporating the considerations from the proceedings of public hearing and responses received through other media ▪ Forwards updated EIA report to the EAC for appraisal ▪ Either accepts the recommendations of EAC or asks for reconsideration of specific issues for review by the EAC. ▪ Takes the final decision – acceptance/ rejection – of the project proposal and communicates the same to the project proponent
State Government	<ul style="list-style-type: none"> ▪ Identifies experts as per the composition specified in the Notification and subsequent guidelines to recommend to the the Central Government. ▪ Extends funding support to fulfill the functions of SEIAA/SEAC ▪ Engages other public agency for conducting public hearings in cases where the SPCB does not respond within time ▪ State Governments will suitably pay the public agency for conducting such activity
EAC	<ul style="list-style-type: none"> ▪ Reviews Form 1 and its attachments ▪ Visits site(s), if necessary ▪ Finalizes ToR and recommends to the Central Government, which in turn communicates the finalized ToR to the project proponent, if not exempted by the Notification ▪ Reviews EIA report, proceedings and appraises their views to the Central government ▪ If the Central Government has any specific views, then the EAC reviews again for appraisal
SEIAA	<ul style="list-style-type: none"> ▪ Receives application from the project proponent ▪ Considers SEAC's views for finalization of ToR ▪ Communicates the finalized ToR to the project proponent ▪ Receives EIA report from project proponent ▪ Uploads the summary of EIA report in the website in cases of Category B projects ▪ Forwards the responses received to the project proponent ▪ Receives updated EIA report from project proponent incorporating the considerations from the proceedings of public hearing and responses received through other media ▪ Forwards updated EIA report to SEAC for appraisal ▪ Either accepts the recommendations of SEAC or asks for reconsideration of specific issues for review by SEAC. ▪ Takes the final decision and communicates the same to the project proponent
SEAC	<ul style="list-style-type: none"> ▪ Reviews Form 1 ▪ If necessary visits, site(s) for finalizing the ToR ▪ Reviews updated EIA - EMP report and ▪ Appraises the SEIAA
SPCB	<ul style="list-style-type: none"> ▪ Receives request from project proponent and conducts public hearing in the manner prescribed. ▪ Conveys proceedings to concerned authority and project proponent
Public Agency	<ul style="list-style-type: none"> ▪ Receives request from the respective Governments to conduct public hearing ▪ Conducts public hearing in the manner prescribed. ▪ Conveys proceedings to the concerned Authority/EAC /Project proponent

5.1 SEIAA

- SEIAA is constituted by the MoEF to take final decision regarding the acceptance/rejection of prior environmental clearance to the project proposal for all Category 'B' projects.

Stakeholders' Roles and Responsibilities

- The state government may decide whether to house them at the Department of Environment or at any other Board for effective operational support.
- State Governments can decide whether the positions are permanent or part-time. The Central Government (MoEF) continues to follow the model of paying fee (TA/DA, accommodation, sitting fee) to the Chairperson and the members of EAC. As such, the State Government is to fund SEIAA & SEAC and decide the appropriate institutional support for them.

A. Constitution

- SEIAA is constituted by the Central Government comprising of three members including a Chairperson and Member–Secretary to be nominated by the State Government or UT Administration concerned.
- The Central Government will notify as and when the nominations (in order) are received from the State Governments, within 30 days from the date of receipt.
- The Chairperson and the non-official member shall have a fixed term of three years, from the date of Notification by the Central Government constituting the Authority.

The form used by the State Governments to submit nominations for Notification by the Central Government is provided in **Annexure X**.

B. Composition

- Chairperson shall be an expert in the EIA process
- Member–Secretary shall be a serving officer of the concerned State Government/ UT Administration familiar with the environmental laws.
- Member–Secretary may be of a level equivalent to the Director, Dept. of Environment or above – a full time member.
- All the members including the Chairperson shall be the experts as per the criteria set in the Notification.
- The Government servants can only serve as the Member–Secretary to SEIAA and the Secretary to SEAC. All other members including Chairperson of the SEIAA and SEAC shall not be comprised of serving Government Officers; industry representatives; and the activists.
- Serving faculty (academicians) is eligible for the membership in the Authority and/or the Committees, if they fulfill the criteria given in Appendix VI to the Notification.
- This is to clarify that the serving Government officers shall not be nominated as professional/expert member of SEIAA/SEAC/EAC.
- Professionals/Experts in the SEIAA and SEAC shall be different.
- Summary regarding the eligibility criteria for Chairperson and Members of the SEIAA is given in Table 5-3.

C. Decision-making process

- The decision of the Authority shall be arrived through consensus.
- If there is no consensus, the Authority may either ask SEAC for reconsideration or may reject the approval.

Stakeholders' Roles and Responsibilities

- All decisions of the SEIAA shall be taken in a meeting and shall ordinarily be unanimous. In case a decision is taken by majority, details of views, for and against the decision, shall be clearly recorded in minutes of meeting and a copy thereof shall be sent to MoEF.

Table 5-3: SEIAA: Eligibility Criteria for Chairperson/ Members/ Secretary

S. No.	Attribute		Requirement		
			Members	Member–Secretary	Chairperson
1	Professional qualification as per the Notification		Compulsory	Compulsory	Compulsory
2	Experience (Fulfilling any one of a, b, c)	a	Professional Qualification + 15 years of experience in one of the expertise area mentioned in the Appendix VI	Professional Qualification + 15 years of experience in one of the expertise area mentioned in the Appendix VI	Professional Qualification + 15 years of experience in one of the expertise area mentioned in the Appendix VI
		b	Professional Qualification +PhD+10 years of experience in one of the expertise area mentioned in Appendix VI	Professional Qualification +PhD+10 years of experience in one of the expertise area mentioned in the Appendix VI	Professional Qualification +PhD+10 years of experience in one of the expertise area mentioned in the Appendix VI
		c	Professional Qualification +10 years of experience in one of the expertise area mentioned in the Appendix VI + 5 years interface with environmental issues, problems and their management	Professional Qualification +10 years of experience in one of the expertise area mentioned in the Appendix VI + 5 years interface with environmental issues, problems and their management	-----
3	Test of independence (conflict of interest) and minimum grade of the Secretary of the Authority		<p>Shall not be a serving government officer</p> <p>Shall not be a person engaged in industry and their associations</p> <p>Shall not be a person associated with environmental activism</p>	<p>Only serving officer from the State Government (DoE) familiar with environmental laws not below the level of Director</p>	<p>Shall not be a serving government officer</p> <p>Shall not be a person engaged in industry and their associations</p> <p>Shall not be a person associated with environmental activism</p>
4	Age		Below 67 years at the time of Notification of the Authority	As per State Government Service Rules	Below 72 Years at the time of the Notification of the Authority
5	Other memberships in Central/State Expert		Shall not be a member in any	Shall not be a member in any	Shall not be a member in any

Stakeholders' Roles and Responsibilities

S. No.	Attribute	Requirement		
		Members	Member–Secretary	Chairperson
	Appraisal Committee	SEIAA/EAC/SEAC	SEIAA/EAC/SEAC	SEIAA/EAC/SEAC
6	Tenure of earlier appointment (continuous)	Only one term before this in continuity is permitted	Not applicable	Only one term before this in continuity is permitted
7	Eminent environmental expertise with understanding on environmental aspects and impacts	Desirable	Desirable	Compulsory
8	Expertise in the environmental clearance process	Desirable	Desirable	Compulsory

Note:

1. A member after continuous membership in two terms (6 years) shall not be considered for further continuation. His/her nomination may be considered after a gap of one term (three years), if other criteria meet.
2. Chairperson/Member once notified may not be removed prior to the tenure of three years without cause and proper enquiry.

5.2 EAC and SEAC

EAC and SEAC are independent Committees to review each developmental activity and offer its recommendations for consideration of the Central Government and SEIAA respectively.

A. Constitution

- EAC and SEAC shall be constituted by the Central Government comprising a maximum of 15 members including a Chairperson and Secretary. In case of SEAC, the State Government or UT Administration is required to nominate the professionals/experts for consideration and Notification by the Central Government.
- The Central Government will notify as and when the nominations (in order) are received from the State Governments, within 30 days from the date of receipt.
- The Chairperson and the non-official member shall have a fixed term of three years, from the date of Notification by the Central Government.
- The Chairperson shall be an eminent environmental expert with understanding on environmental aspects and environmental impacts. The Secretary of the SEAC shall be a State Government officer, not below the level of a Director/Chief Engineer.
- The members of the SEAC need not be from the same State/UT.
- In case the State Governments/UTs so desire, the MoEF can form regional EAC to serve the concerned States/UTs.
- State Governments may decide to their convenience to house SEAC at the Department of Environment or at SPCB or at any other department, to extend support to the SEAC activities.

B. Composition

- Composition of EAC/SEAC as per the Notification is given in **Annexure XI**.
- Secretary to EAC/SEAC may invite a maximum of two professionals/experts with the prior approval of the Chairperson, if desired, for taking the advisory inputs for appraisal. In such case, the invited experts will not take part in the decision making process.
- The Secretary of each EAC/SEAC preferably be an officer of the level equivalent to or above the level of Director, MoEF, GoI.

C. Decision making

The EAC and SEAC shall function on the principle of collective responsibility. The Chairperson shall endeavour to reach a consensus in each case, and if consensus cannot be reached, the view of the majority shall prevail.

D. Operational issues

- Secretary may deal with all correspondence, formulate agenda and prepare agenda notes. Chairperson and other members may act only for the meetings.
- Chairperson of EAC/SEAC shall be one among the expert members having considerable professional experience with proven credentials.
- EAC/SEAC shall meet at least once every month or more frequently, if so needed, to review project proposals and to offer recommendations for the consideration of the Authority.
- EAC/SEAC members may inspect the site at various stages *i.e.* during screening, scoping and appraisal, as per the need felt and decided by the Chairperson of the Committee.
- The respective Governments through the Secretary of the Committee may pay/reimburse the participation expenses, honorarium *etc.*, to the Chairperson and members.

i. Tenure of EAC/SEIAA/SEAC

The tenure of Authority/Committee(s) shall be for a fixed period of three years. At the end of the three years period, the Authority and the committees need to be re-constituted. However, staggered appointment dates may be adopted to maintain continuity of members at a given point of time.

ii. Qualifying criteria for nomination of a member to EAC/SEIAA/SEAC

While recommending nominations and while notifying the members of the Authority and Expert Committees, it shall be ensured that all the members meet the following three criteria:

- Professional qualification
- Relevant experience/Experience interfacing with environmental management
- Absence of conflict of interest

These are elaborated subsequently.

a) Professional qualification

The person should have at least (i) 5 years of formal University training in the concerned discipline leading to a MA/MSc Degree, or (ii) in case of Engineering/Technology/Architecture disciplines, 4 years formal training in a professional training course together with prescribed practical training in the field leading to a B.Tech/B.E./B.Arch. Degree, or (iii) Other professional degree (e.g. Law) involving a total of 5 years of formal University training and prescribed practical training, or (iv) Prescribed apprenticeship/articleship and pass examinations conducted by the concerned professional association (e.g. MBA/IAS/IFS). In selecting the individual professionals, experience gained by them in their respective fields will be taken note of.

b) Relevant experience

- Experience shall be related to professional qualification acquired by the person and be related to one or more of the expertise mentioned for the expert members. Such experience should be a minimum of 15 years.
- When the experience mentioned in the foregoing sub-paragraph interfaces with environmental issues, problems and their management, the requirement for the length of the experience can be reduced to a minimum of 10 years.

c) Absence of conflict of interest

For the deliberations of the EAC/SEAC to be independent and unbiased, all possibilities of potential conflict of interests have to be eliminated. Therefore, serving government officers; persons engaged in industry and their associations; persons associated with the formulation of development projects requiring prior environmental clearance, and persons associated with environmental activism shall not be considered for membership of SEIAA/ SEAC/ EAC.

iii. Age

Below 70 years for the members and below 72 years for the Chairperson of the SEIAA/SEAC/EAC. The applicability of the age is at the time of the Notification of the SEIAA/SEAC/EAC by the Central Government.

Summary regarding the eligibility criteria for Chairperson and Members of the EAC/SEAC is given in Table 5-4.

Table 5-4: EAC/SEAC: Eligibility Criteria for Chairperson / Members / Secretary

S. No.	Attribute		Requirement		
			Expert members	Secretary	Chairperson
1	Professional qualification as per the Notification		Compulsory	Compulsory	Compulsory
2	Experience (Fulfilling any one of a, b, c)	a	Professional Qualification + 15 years of experience in one of the expertise area mentioned in the Appendix VI	Professional Qualification + 15 years of experience in one of the expertise area mentioned in the Appendix VI	Professional Qualification + 15 years of experience in one of the expertise area mentioned in the Appendix VI

Stakeholders' Roles and Responsibilities

S. No.	Attribute	Requirement			
		Expert members	Secretary	Chairperson	
		b	Professional Qualification +PhD+10 years of experience in one of the expertise area mentioned in the Appendix VI	Professional Qualification +PhD+10 years of experience in one of the expertise area mentioned in the Appendix VI	Professional Qualification +PhD+10 years of experience in one of the expertise area mentioned in the Appendix VI
		c	Professional Qualification +10 years of experience in one of the expertise area mentioned in the Appendix VI + 5 years interface with environmental issues, problems and their management	Professional Qualification +10 years of experience in one of the expertise area mentioned in the Appendix VI + 5 years interface with environmental issues, problems and their management	-----
3	Test of independence (conflict of interest) and minimum grade of the Secretary of the Committees	<p>Shall not be a serving government officer</p> <p>Shall not be a person engaged in industry and their associations</p> <p>Shall not be a person associated with environmental activism</p>	<p>In case of EAC, not less than a Director from the MoEF, Government of India</p> <p>In case of SEAC, not below the level of Director/Chief Engineer from the State Government (DoE)</p>	<p>Shall not be a serving government officer</p> <p>Shall not be a person engaged in industry and their associations</p> <p>Shall not be a person associated with environmental activism</p>	
4	Age	Below 67 years at the time of Notification of the Committee	As per state Government Service Rules	Below 72 Years at the time of the Notification of the Committee	
5	Membership in Central/State Expert Appraisal committees	Only one other than this nomination is permitted	Shall not be a member in other SEIAA/EAC/SEAC	Shall not be a member in any other SEIAA/EAC/SEAC	
6	Tenure of earlier appointment (continuous)	Only one term before this in continuity is permitted	Not applicable	Only one term before this in continuity is permitted	
7	Eminent environmental expertise with understanding on environmental aspects and impacts	Desirable	Not applicable	Compulsory	

Notes:

1. A member after continuous membership in two terms (six years) shall not be considered for further continuation. His/her nomination may be reconsidered after a gap of one term (three years), if other criteria meet.

Stakeholders' Roles and Responsibilities

2. Chairperson/Member once notified may not be removed prior to the tenure of 3 years with out cause and proper enquiry. A member after continuous membership in two terms (6 years) shall not be considered for further continuation. The same profile may be considered for nomination after a gap of three years, i.e., one term, if other criteria are meeting.

E. Other conditions that may be considered

- An expert member of one State/UT, can have at the most another State/UT Committee membership, but in no case more than two Committees at a given point of time.
- An expert member of a Committee shall not have membership continuously in the same committee for more than two terms, i.e. six years. They can be nominated after a gap of three years, i.e., one term. When a member of Committee has been associated with any development project, which comes for prior environmental clearance, he/she may not participate in the deliberations and the decisions in respect to that particular project.
- At least four members shall be present in each meeting to fulfill the quorum
- If a member does not consecutively attend six meetings, without prior intimation to the Committee his/her membership may be terminated by the Notifying Authority. Prior information for absence due to academic pursuits, career development and national/state-endorsed programmes may be considered as genuine grounds for retention of membership.

ANNEXURE I
A Compilation of Legal Instruments

Sl. No.	Legal Instrument (Type, Reference, Year)	Responsible Ministries or Bodies	Chemical Use Categories/ Pollutants	Objective of Legislation	Relevant Articles/Provisions
1	Air (Prevention and Control of Pollution) Act, 1981 amended 1987	Central Pollution Control Board and State Pollution Control Boards	Air pollutants from chemical industries	The prevention, control and abatement of air pollution	Section 2: Definitions Section 21: Consent from State Boards Section 22: Not to allow emissions exceeding prescribed limits Section 24: Power of Entry and Inspection Section 25: Power to Obtain Information Section 26: Power to Take Samples Section 37-43: Penalties and Procedures
2	Air (Prevention and Control of Pollution) (Union Territories) Rules, 1983	Central Pollution Control Board and State Pollution Control Boards	Air pollutants from chemical industries	The prevention, control and abatement of air pollution	Rule 2: Definitions Rule 9: Consent Applications
3	Water (Prevention and Control of Pollution) Act, 1974 amended 1988	Central Pollution Control Board and State Pollution Control Boards	Water Pollutants from water polluting industries	The prevention and control of water pollution and also maintaining or restoring the wholesomeness of water	Section 2: Definitions Section 20: Power to Obtain Information Section 21: Power to Take Samples Section 23: Power of Entry and Inspection Section 24: Prohibition on Disposal Section 25: Restriction on New Outlet and New Discharge Section 26: Provision regarding existing discharge of sewage or trade effluent Section 27: Refusal or withdrawal of consent by state boards Section 41-49: Penalties and Procedures
4	Water (Prevention and Control of Pollution) Rules, 1975	Central Pollution Control Board and State Pollution Control Boards	Water Pollutants from water polluting industries	The prevention and control of water pollution and also maintaining or restoring the wholesomeness of water	Rule 2: Definitions Rule 30: Power to take samples Rule 32: Consent Applications

5	The Environment (Protection) Act, 1986, amended 1991	Ministry of Environment and Forests, Central Pollution Control Board and State Pollution Control Boards	All types of environmental pollutants	Protection and Improvement of the Environment	Section 2: Definitions Section 7: Not to allow emission or discharge of environmental pollutants in excess of prescribed standards Section 8: Handling of Hazardous Substances Section 10: Power of Entry and Inspection Section 11: Power to take samples Section 15-19: Penalties and Procedures
6	Environmental (Protection) Rules, 1986 (Amendments in 1999, 2001, 2002, 2002, 2002, 2003, 2004)	Ministry of Environment and Forests, Central Pollution Control Board and State Pollution Control Boards	All types of Environmental Pollutants	Protection and Improvement of the Environment	Rule 2: Definitions Rule 3: Standards for emission or discharge of environmental pollutants Rule 5: Prohibition and restriction on the location of industries and the carrying on process and operations in different areas Rule 13: Prohibition and restriction on the handling of hazardous substances in different areas Rule 14: Submission of environmental statement
7	Hazardous Waste (Management and Handling) Rules, 1989 amended 2000 and 2003	MoEF, CPCB, SPCB, DGFT, Port Authority and Customs Authority	Hazardous Wastes generated from industries using hazardous chemicals	Management & Handling of hazardous wastes in line with the Basel convention	Rule 2: Application Rule 3: Definitions Rule 4: Responsibility of the occupier and operator of a facility for handling of wastes Rule 4A: Duties of the occupier and operator of a facility Rule 4B: Duties of the authority Rule 5: Grant of authorization for handling hazardous wastes Rule 6: Power to suspend or cancel authorization Rule 7: Packaging, labeling and transport of hazardous wastes Rule 8: Disposal sites

					<p>Rule 9: Record and returns</p> <p>Rule 10: Accident reporting and follow up</p> <p>Rule 11: Import and export of hazardous waste for dumping and disposal</p> <p>Rule 12: Import and export of hazardous waste for recycling and reuse</p> <p>Rule 13: Import of hazardous wastes</p> <p>Rule 14: Export of hazardous waste</p> <p>Rule 15: Illegal traffic</p> <p>Rule 16: Liability of the occupier, transporter and operator of a facility</p> <p>Rule 19: Procedure for registration and renewal of registration of recyclers and re-refiners</p> <p>Rule 20: Responsibility of waste generator</p>
8	Manufacture Storage and Import of Hazardous Chemicals Rules, 1989 amended 2000	Ministry of Environment & Forests, Chief Controller of Imports and Exports, CPCB, SPCB, Chief Inspector of Factories, Chief Inspector of Dock Safety, Chief Inspector of Mines, AERB, Chief Controller of Explosives, District Collector or District Emergency Authority, CEES under DRDO	Hazardous Chemicals - Toxic, Explosive, Flammable, Reactive	Regulate the manufacture, storage and import of Hazardous Chemicals	<p>Rule 2: Definitions</p> <p>Rule 4: responsibility of the Occupier</p> <p>Rule 5: Notification of Major Accidents</p> <p>Rule 7-8: Approval and notification of site and updating</p> <p>Rule 10-11: Safety Reports and Safety Audit reports and updating</p> <p>Rule 13: Preparation of Onsite Emergency Plan</p> <p>Rule 14: Preparation of Offsite Emergency Plan</p> <p>Rule 15: Information to persons likely to get affected</p> <p>Rule 16: Proprietary Information</p> <p>Rule 17: Material Safety Data Sheets</p> <p>Rule 18: Import of Hazardous Chemicals</p>
9	Chemical Accidents (Emergency Planning, Preparedness and Response) Rules, 1996	CCG, SCG, DCG, LCG and MAH Units	Hazardous Chemicals - Toxic, Explosive, Flammable, Reactive	Emergency Planning Preparedness and Response to chemical accidents	<p>Rule 2: Definitions</p> <p>Rule 5: Functions of CCG</p> <p>Rule 7: Functions of SCG</p> <p>Rule 9: Functions of DCG</p> <p>Rule 10: Functions of LCG</p>
10	Ozone Depleting Substances	Ministry of Environment &	Ozone depleting substances	Regulate the production, import, use, sale, purchase and	<p>Rule 2: Definitions</p> <p>Rule 3: Regulation of production and</p>

	(Regulation and Control) Rules, 2000	Forests		phase-out of the ODS	consumption of ozone depleting substances Rule 4: Prohibition on export to or import from countries not specified in Schedule VI Rule 5: Ozone depleting substances are to be exported to or imported from countries specified in Schedule VI under a license Rule 6: Regulation of the sale of ozone depleting substances Rule 7: Regulation on the purchase of ozone depleting substances Rule 8: Regulation on the use of ozone depleting substance Rule 9: Prohibition on new investments with ozone depleting substances Rule 10: Regulation of import, export and sale of products made with or containing ozone depleting substances Rule 11: Regulation on reclamation and destruction of ozone depleting substances Rule 12: Regulation on manufacture, import and export of compressors Rule 13: Procedure for registration, cancellation of registration and appeal against such orders Rule 14: Monitoring and reporting requirements
11	EIA Notification, 2006	MoEF, SPCB	For all the identified developmental activities in the notification	Requirement of environmental clearance before establishment of or modernization / expansion of identified developmental projects.	Requirements and procedure for seeking environmental clearance of projects
12	Batteries (Management and Handling) Rules, 2001.	SPCB, CPCB and MoEF	Lead Acid Batteries	To control the hazardous waste generation (lead waste) from used lead acid batteries	Rule 2: Application Rule 3: Definitions Rule 4: Responsibilities of manufacturer, importer, assembler and re-conditioner Rule 5: Registration of Importers Rule 7: Responsibilities of dealer Rule 8: Responsibilities of recycler Rule 9: Procedure for registration / renewal of

					<p>registration of recyclers Rule 10: Responsibilities of consumer or bulk consumer Rule 11: Responsibilities of auctioneer Rule 14: Computerization of Records and Returns</p>
13	Public Liability Insurance Act, 1991 amended 1992	Ministry of Environment & Forests, District Collector	Hazardous Substances	To provide immediate relief to persons affected by accident involving hazardous substances	<p>Section 2: Definitions Section 3: Liability to give relief in certain cases on principle of no fault Section 4: Duty of owner to take out insurance policy Section 7A: Establishment of Environmental Relief Fund Section 14-18: Penalties and Offences</p>
14	Public Liability Insurance Rules, 1991 amended 1993	Ministry of Environment & Forests, District Collector	Hazardous Substances	To provide immediate relief to persons affected by accident involving hazardous substances and also for Establishing an Environmental Relief fund	<p>Rule 2: Definitions Rule 6: Establishment of administration of fund Rule 10: Extent of liability Rule 11: Contribution of the owner to environmental relief fund</p>
15	Factories Act, 1948	Ministry of Labour, DGFASLI and Directorate of Industrial Safety and Health/Factories Inspectorate	Chemicals as specified in the Table	Control of workplace environment, and providing for good health and safety of workers	<p>Section 2: Interpretation Section 6: Approval, licensing and registration of factories Section 7A: General duties of the occupier Section 7B: General duties of manufacturers etc., as regards articles and substances for use in factories Section 12: Disposal of wastes and effluents Section 14: Dust and fume Section 36: Precautions against dangerous fumes, gases, etc. Section 37: Explosion or inflammable dust, gas, etc. Chapter IVA: Provisions relating to Hazardous processes Section 87: Dangerous operations Section 87A: Power to prohibit employment on</p>

					account of serious hazard Section 88: Notice of certain accident Section 88A: Notice of certain dangerous occurrences Chapter X: Penalties and procedures
16	The Explosives Act, 1884	Ministry of Commerce and Industry (Department of Explosives)	Explosive substances as defined under the Act	To regulate the manufacture, possession, use, sale, transport, export and import of explosives with a view to prevent accidents	Section 4: Definition Section 6: Power for Central government to prohibit the manufacture, possession or importation of especially dangerous explosives Section 6B: Grant of Licenses
17	The Explosive Rules, 1983	Ministry of Commerce and Industry and Chief Controller of Explosives, port conservator, customs collector, railway administration	Explosive substances as defined under the Act	To regulate the manufacture, possession, use, sale, transport, export and import of explosives with a view to prevent accidents	Rule 2: Definition Chapter II: General Provisions Chapter III: Import and Export Chapter IV: Transport Chapter V: Manufacture of explosives Chapter VI: Possession sale and use Chapter VII: Licenses
18	The Motor Vehicle Act, 1988	Ministry of Shipping, Road Transport and Highways	Hazardous and Dangerous Goods	To consolidate and amend the law relating to motor vehicles	Section 2: Definition Chapter II: Licensing of drivers of motor vehicle Chapter VII: Construction equipment and maintenance of motor vehicles
19	The Central Motor Vehicle Rules, 1989	Ministry of Shipping, Road Transport and Highways	Hazardous and Dangerous Goods	To consolidate and amend the law relating to motor vehicles including to regulate the transportation of dangerous goods with a view to prevent loss of life or damage to the environment	Rule 2: Definition Rule 9: Educational qualification for driver's of goods carriages carrying dangerous or hazardous goods Rule 129: Transportation of goods of dangerous or hazardous nature to human life Rule 129A: Spark arrestors Rule 130: Manner of display of class labels Rule 131: Responsibility of the consignor for safe transport of dangerous or hazardous goods Rule 132: Responsibility of the transporter or owner of goods carriage Rule 133: Responsibility of the driver Rule 134: Emergency Information Panel Rule 135: Driver to be instructed

					Rule 136: Driver to report to the police station about accident Rule 137: Class labels
20	The Custom Act, 1962	CBEC, Ministry of Finance	Hazardous Goods	To prevent entry of illegal hazardous goods or banned goods including hazardous or banned chemicals	Section 2: definitions Section 11: Power to Prohibit Importation or Exportation of Goods
21	The Merchant Shipping Act, 1958 amended in 2002 and 2003	Ministry of Shipping, Road Transport and Highways	All packaged cargo including Dangerous and hazardous goods as defined in the rules	For safe handling and transportation of cargo including dangerous goods to prevent accident	Section 3: Definitions Section 331: Carriage of Dangerous Goods
22	Merchant Shipping (carriage of Cargo) Rules 1995	Ministry of Shipping, Road Transport and Highways	All packaged cargo including Dangerous and hazardous goods as defined in the rules	For safe handling and transportation of cargo including dangerous goods to prevent accident	
23	The Indian Port Act, 1908	Ministry of Shipping, Road Transport and Highways	All Chemicals - handling and storage	For control of activities on ports including safety of shipping and conservation of ports	Section 2: Definitions Chapter IV: Rules for the safety of shipping and the conservation of ports Chapter VII: Provisions with respect to penalties
24	The Dock Workers, (Safety, Health and Welfare) Act, 1986	Ministry of Labour, DGFASLI and Directorate of Dock Safety	All Chemicals termed as dangerous goods	Safety of Dock workers including handling of dangerous goods	
25	The Dock Workers, (Safety, Health and Welfare) Rules, 1990	Ministry of Labour, DGFASLI and Directorate of Dock Safety	All Chemicals termed as dangerous goods	Safety of Dock workers including handling of dangerous goods	

ANNEXURE II
General Standards for Discharge of Environmental Pollutants as per
CPCB

Table: Water Quality Standards

S. No.	Parameter	Standards			
		Inland Surface Water	Public Sewer	Land for Irrigation	Marine Coastal Areas
1.	2.	3.			
		(a)	(b)	(c)	(d)
1.	Colour and odour	See Note-1	—	See Note-1	See Note-1
2.	Suspended Solids, mg/l, Max	100	600	200	(a) For process waste water-100 (b) For cooling water effluent-10 per cent above total suspended matter of influent cooling water.
3.	Particle size of suspended solids	Shall pass 850 micron IS Sieve	—	—	(a) Floatable solids, Max 3 mm (b) Settleable solids Max 850 microns.
4.	Dissolved solids (inorganic), mg/a, mac	2100	2100	2100	—
5.	pH value	5.5 to 9.0	5.5 to 9.0	5.5 to 9.0	5.5 to 9.0
6.	Temperature °C, Max	Shall not exceed 40 in any section of the stream within 15 meters down stream from the effluent outlet	45 at the point of discharge	—	45 at the point of discharge
7.	Oil and grease, mg/l, max	10	20	10	20
8.	Total residual chlorine, mg/l, Max.	1.0	—	—	1.0
9.	Ammonical nitrogen (as N), mg/l, Max.	50	50	—	50
10.	Total Kjeldahl nitrogen (as N), mg/l, Max.	100	—	—	100
11.	Free Ammonia (as NH ₃), mg/l, Max.	5.0	—	—	5.0
12.	Biochemical Oxygen Demand (5 days at 20°C) Max.	30	350	100	100
13.	Chemical Oxygen Demand, mg/l, Max.	250	—	—	250
14.	Arsenic (as As), mg/l, Max.	0.2	0.2	0.2	0.2
15.	Mercury (as Hg), mg/l, Max.	0.01	0.01	—	0.01
16.	Lead (as Pb), mg/l, Max.	0.1	1.0	—	1.0
17.	Cadmium (as Cd), mg/l, Max.	2.0	1.0	—	2.0

18.	Hexavalent chromium (as Cr+6) mg/l, Max.	0.1	2.0	—	1.0
19.	Total chromium as (Cr), mg/l, Max.	2.0	2.0	—	2.0
20.	Copper (as Cu), mg/l, Max.	3.0	3.0	—	3.0
21.	Zinc (as Zn), mg/l, Max.	5.0	15	—	15
22.	Selenium (as Se), mg/l, Max.	0.05	0.05	—	0.05
23.	Nickel (as Ni), mg/l, Max.	3.0	3.0	—	5.0
24.	Boron (as B), mg/l, Max.	2.0	2.0	2.0	—
25.	Percent Sodium, Max.	—	60	60	—
26.	Residual sodium carbonate, mg/l, Max.	—	—	5.0	—
27.	Cyanide (as CN), mg/l, Max.	0.2	2.0	0.2	0.2
28.	Chloride (as Cl), mg/l, Max.	1000	1000	600	(a)
29.	Fluoride (as F), mg/l, Max.	2.0	15	—	15
30.	Dissolved Phosphates (as P), mg/l, Max.	5.0	—	—	—
31.	Sulphate (as SO ₄), mg/l, Max.	1000	1000	1000	—
32.	Sulphide (as S), mg/l, Max.	2.0	—	—	5.0
33.	Pesticides	Absent	Absent	Absent	Absent
34.	Phenolic compounds (as C ₆ H ₅ OH), mg/l, Max.	1.0	5.0	—	5.0
35.	Radioactive materials				
	(a) Alpha emitters MC/ml, Max.	10 ⁻⁷	10 ⁻⁷	10 ⁻⁸	10 ⁻⁷
	(b) Beta emitters uc/ml, Max.	10 ⁻⁶	10 ⁻⁶	10 ⁻⁷	10 ⁻⁶

Note :-

1. All efforts should be made to remove colour and unpleasant odour as far as practicable.
2. The standards mentioned in this notification shall apply to all the effluents discharged such as industrial mining and mineral processing activities municipal sewage etc.

Table: Noise Standards

Ambient air quality standards in respect of noise

Area Code	Category of Area	Limits in dB (A) Leq	
		Day Time	Night Time
(A)	Industrial area	75	70
(B)	Commercial area	65	55
(C)	Residential area	55	45
(D)	Silence zone	50	40

Note :

1. Day time is reckoned in between 6.00 AM and 9.00 PM
2. Night time is reckoned in between 9.00 PM and 6.00 AM
3. Silence zone is defined as areas upto 100 meters around such premises as hospitals, educational institutions and courts. The Silence zones are to be declared by the Competent Authority.
4. Use of vehicular horns, loudspeakers and bursting of crackers shall be banned in these zones.
5. Mixed categories of areas should be declared as one of the four above mentioned categories by the Competent Authority and the corresponding standards shall apply.

Standards/Guidelines for Control of Noise Pollution from Stationary Diesel Generator (DG) Sets

(A) Noise Standards for DG Sets (15-500 KVA)

The total sound power level, L_w , of a DG set should be less than, $94+10 \log_{10} (KVA)$, dB (A), at the manufacturing stage, where, KVA is the nominal power rating of a DG set.

This level should fall by 5 dB (A) every five years, till 2007, i.e. in 2002 and then in 2007.

(B) Mandatory acoustic enclosure/acoustic treatment of room for stationary DG sets (5 KVA and above)

Noise from the DG set should be controlled by providing an acoustic enclosure or by treating the room acoustically.

The acoustic enclosure/acoustic treatment of the room should be designed for minimum 25 dB(A) Insertion Loss or for meeting the ambient noise standards, whichever is on the higher side (if the actual ambient noise is on the higher side, it may not be possible to check the performance of the acoustic enclosure/acoustic treatment. Under such circumstances the performance may be checked for noise reduction upto actual ambient noise level, preferably, in the night time). The measurement for Insertion Loss may be done at different points at 0.5m from the acoustic enclosure/room, and then averaged.

The DG set should also be provide with proper exhaust muffler with Insertion Loss of minimum 25 dB(A).

(C) Guidelines for the manufacturers/users of DG sets (5 KVA and above)

1. The manufacturer should offer to the user a standard acoustic enclosure of 25 dB(A) Insertion Loss and also a suitable exhaust muffler with Insertion Loss of 25 dB(A).

2. The user should make efforts to bring down the noise levels due to the DG set, outside his premises, within the ambient noise requirements by proper siting and control measures.
3. The manufacturer should furnish noise power levels of the unlicensed DG sets as per standards prescribed under (A)
4. The total sound power level of a DG set, at the user's end, shall be within 2 dB(A) of the total sound power level of the DG set, at the manufacturing stage, as prescribed under (A).
5. Installation of a DG set must be strictly in compliance with the recommendation of the DG set manufacturer.
6. A proper routine and preventive maintenance procedure for the DG set should be set and followed in consultation with the DG set manufacturer which would help prevent noise levels of the DG set from deteriorating with use.

Order of the Lt. Governor of Delhi in respect of D.G. Sets (5th December, 2001)

In exercise of the powers conferred by section 5 of the Environment (Protection) Act, 1986, (29 of 1986), read with the Government of India, Ministry of Home Affairs notification S.O. 667 (E) bearing No. F.No. U-11030/J/91-VTL dated 10th September, 1992, the Lt. Governor of Government of National Capital of Delhi hereby directs to all owners/users of generators sets in the National Capital Territory of Delhi as follows :-

1. that generator sets above the capacity of 5 KVA shall not be operated in residential areas between the hours of 10.00 PM to 6.00 AM;
2. that the generator sets above the capacity of 5 KVA in all areas residential/commercial/industrial shall operate only with the mandatory acoustic enclosures and other standards prescribed in the Environment (Protection) Rules, 1986;
3. that mobile generator sets used in social gatherings and public functions shall be permitted only if they have installed mandatory acoustic enclosures and adhere to the prescribed standards for noise and emission as laid down in the Environment (Protection) Rules, 1986.

The contravention of the above directions shall make the offender liable for prosecution under section 15 of the said Act which stipulates punishment of imprisonment for a term which may extend to five years with fine which may extend to one lakh rupees, or with both, and in case the failure of contravention continues, with additional fine which may extend to five thousand rupees for every day during which such failure or contravention continues after the conviction for the first such failure or contravention and if still the failure or contravention continues beyond a period of one year after the date of contravention, the offender continues beyond a period of one year after the date of contravention, the offender shall be punishable with imprisonment for a term which may extend to seven years.

Order Dated: 21st June, 2002

In exercise of the powers conferred by section 5 of the Environment (Protection) Act, 1986 (29 of 1986) read with the Govt. of India, Ministry of Home Affairs notification S.O. 667(E) bearing No. U-11030/J/91-VTL dated the 10th September, 1992, the Lt. Governor Govt. of the National Capital Territory of Delhi hereby makes the following amendment/modification in his order dated the 5th December, 2001 regarding the operation of generator sets, namely:-

Amendments/modifications

In the above said order, for clause(1), the following shall be substituted, namely:-

“(1) that the generator sets above 5KVA shall not be operated in residential areas between the hours from 10.00 p.m. to 6.00 a.m. except generator sets of Group Housing Societies and Multi-storey residential apartments”.

DIESEL GENERATOR SETS: STACK HEIGHT

The minimum height of stack to be provided with each generator set can be worked out using the following formula:

$$H = h + 0.2 \times \sqrt{KVA}$$

H = Total height of stack in metre

h = Height of the building in metres where the generator set is installed

KVA = Total generator capacity of the set in KVA

Based on the above formula the minimum stack height to be provided with different range of generator sets may be categorized as follows:

For Generator Sets	Total Height of stack in metre
50 KVA	Ht. of the building + 1.5 metre
50-100 KVA	Ht. of the building + 2.0 metre
100- 150 KVA	Ht. of the building + 2.5 metre
150-200 KVA	Ht. of the building + 3.0 metre
200-250 KVA	Ht. of the building + 3.5 metre
250-300 KVA	Ht. of the building + 3.5 metre

Similarly for higher KVA ratings a stack height can be worked out using the above formula

Source: Evolved By CPCB

[Emission Regulations Part IV: COINDS/26/1986-87]

ANNEXURE III
Form 1 (Application for Obtaining EIA Clearance)

FORM 1

(I) Basic Information

S. No.	Item	Details
1.	Name of the project/s	
2.	S.No. in the schedule	
3.	Proposed capacity/area/length/tonnage to be handled/command area/lease area/number of wells to be drilled	
4.	New/Expansion/Modernization	
5.	Existing Capacity/Area etc.	
6.	Category of Project i.e., 'A' or 'B'	
7.	Does it attract the general condition? If yes, please specify.	
8.	Does it attract the specific condition? If yes, Please specify.	
9.	Location	
	Plot/Survey/Khasra No.	
	Village	
	Tehsil	
	District	
	State	
10.	Nearest railway station/airport along with distance in kms.	
11.	Nearest Town, city, District headquarters along with distance in kms.	
12.	Village Panchayats, Zilla Parishad, Municipal Corporation, Local body (complete postal addresses with telephone nos. to be given)	
13.	Name of the applicant	
14.	Registered Address	
15.	Address for correspondence:	
	Name	
	Designation (Owner/Partner/CEO)	
	Address	
	Pin Code	
	E-mail	
	Telephone No.	

S. No.	Item	Details
	Fax No.	
16.	Details of alternative Sites examined, if any location of these sites should be shown on a toposheet.	Village-District-State 1. 2. 3.
17.	Interlined Projects	
18.	Whether separate application of interlined project has been submitted	
19.	If yes, date of submission	
20.	If no, reason	
21.	Whether the proposal involves approval/clearance under: if yes, details of the same and their status to be given. (a) The Forest (Conservation) Act, 1980 ? (b) The Wildlife (Protection) Act, 1972 ? (c) The C.R.Z. Notification, 1991 ?	
22.	Whether there is any Government Order/Policy relevant/relating to the site?	
23.	Forest land involved (hectares)	
24.	Whether there is any litigation pending against the project and/or land in which the project is propose to be set up (a) Name of the Court (b) Case No. (c) Orders/directions of the Court, if any and its relevance with the proposed project.	

(II) Activity

1. **Construction, operation or decommissioning of the Project involving actions, which will cause physical changes in the locality (topography, land use, changes in water bodies, etc.)**

S.No.	Information/Checklist confirmation	Yes/No	Details thereof (with approximate quantities /rates, wherever possible) with source of information data
1.1	Permanent or temporary change in land use, land cover or topography including increase in intensity of land use (with respect to local land use plan)		
1.2	Clearance of existing land, vegetation and		

S.No.	Information/Checklist confirmation	Yes/No	Details thereof (with approximate quantities /rates, wherever possible) with source of information data
	buildings?		
1.3	Creation of new land uses?		
1.4	Pre-construction investigations e.g. bore houses, soil testing?		
1.5	Construction works?		
1.6	Demolition works?		
1.7	Temporary sites used for construction works or housing of construction workers?		
1.8	Above ground buildings, structures or earthworks including linear structures, cut and fill or excavations		
1.9	Underground works including mining or tunneling?		
1.10	Reclamation works?		
1.11	Dredging?		
1.12	Offshore structures?		
1.13	Production and manufacturing processes?		
1.14	Facilities for storage of goods or materials?		
1.15	Facilities for treatment or disposal of solid waste or liquid effluents?		
1.16	Facilities for long term housing of operational workers?		
1.17	New road, rail or sea traffic during construction or operation?		
1.18	New road, rail, air waterborne or other transport infrastructure including new or altered routes and stations, ports, airports etc?		
1.19	Closure or diversion of existing transport routes or infrastructure leading to changes in traffic movements?		
1.20	New or diverted transmission lines or pipelines?		
1.21	Impoundment, damming, culverting, realignment or other changes to the hydrology of watercourses or aquifers?		
1.22	Stream crossings?		
1.23	Abstraction or transfers of water form ground or surface waters?		

S.No.	Information/Checklist confirmation	Yes/No	Details thereof (with approximate quantities /rates, wherever possible) with source of information data
1.24	Changes in water bodies or the land surface affecting drainage or run-off?		
1.25	Transport of personnel or materials for construction, operation or decommissioning?		
1.26	Long-term dismantling or decommissioning or restoration works?		
1.27	Ongoing activity during decommissioning which could have an impact on the environment?		
1.28	Influx of people to an area in either temporarily or permanently?		
1.29	Introduction of alien species?		
1.30	Loss of native species or genetic diversity?		
1.31	Any other actions?		

2. Use of Natural resources for construction or operation of the Project (such as land, water, materials or energy, especially any resources which are non-renewable or in short supply):

S.No.	Information/checklist confirmation	Yes/No	Details thereof (with approximate quantities /rates, wherever possible) with source of information data
2.1	Land especially undeveloped or agricultural land (ha)		
2.2	Water (expected source & competing users) unit: KLD		
2.3	Minerals (MT)		
2.4	Construction material – stone, aggregates, sand / soil (expected source – MT)		
2.5	Forests and timber (source – MT)		
2.6	Energy including electricity and fuels (source, competing users) Unit: fuel (MT), energy (MW)		
2.7	Any other natural resources (use appropriate standard units)		

3. Use, storage, transport, handling or production of substances or materials, which could be harmful to human health or the environment or raise concerns about actual or perceived risks to human health.

S.No	Information/Checklist confirmation	Yes/No	Details thereof (with approximate quantities/rates, wherever possible) with source of information data
3.1	Use of substances or materials, which are hazardous (as per MSIHC rules) to human health or the environment (flora, fauna, and water supplies)		
3.2	Changes in occurrence of disease or affect disease vectors (e.g. insect or water borne diseases)		
3.3	Affect the welfare of people e.g. by changing living conditions?		
3.4	Vulnerable groups of people who could be affected by the project e.g. hospital patients, children, the elderly etc.,		
3.5	Any other causes		

4. Production of solid wastes during construction or operation or decommissioning (MT/month)

S.No.	Information/Checklist confirmation	Yes/No	Details thereof (with approximate quantities/rates, wherever possible) with source of information data
4.1	Spoil, overburden or mine wastes		
4.2	Municipal waste (domestic and or commercial wastes)		
4.3	Hazardous wastes (as per Hazardous Waste Management Rules)		
4.4	Other industrial process wastes		
4.5	Surplus product		
4.6	Sewage sludge or other sludge from effluent treatment		
4.7	Construction or demolition wastes		
4.8	Redundant machinery or equipment		
4.9	Contaminated soils or other materials		
4.10	Agricultural wastes		
4.11	Other solid wastes		

5. Release of pollutants or any hazardous, toxic or noxious substances to air (kg/hr)

S.No	Information/Checklist confirmation	Yes/No	Details thereof (with approximate quantities/rates, wherever possible) with source of information data
5.1	Emissions from combustion of fossil fuels from stationary or mobile sources		
5.2	Emissions from production processes		
5.3	Emissions from materials handling including storage or transport		
5.4	Emissions from construction activities including plant and equipment		
5.5	Dust or odours from handling of materials including construction materials, sewage and waste		
5.6	Emissions from incineration of waste		
5.7	Emissions from burning of waste in open air (e.g. slash materials, construction debris)		
5.8	Emissions from any other sources		

6. Generation of Noise and Vibration, and Emissions of Light and Heat:

S.No.	Information/Checklist confirmation	Yes/No	Details thereof (with approximate quantities/rates, wherever possible) with source of information data with source of information data
6.1	From operation of equipment e.g. engines, ventilation plant, crushers		
6.2	From industrial or similar processes		
6.3	From construction or demolition		
6.4	From blasting or piling		
6.5	From construction or operational traffic		
6.6	From lighting or cooling systems		
6.7	From any other sources		

7. Risks of contamination of land or water from releases of pollutants into the ground or into sewers, surface waters, groundwater, coastal waters or the sea:

S.No.	Information/Checklist confirmation	Yes/No	Details thereof (with approximate quantities/rates, wherever possible) with source of information data
7.1	From handling, storage, use or spillage of hazardous materials		
7.2	From discharge of sewage or other effluents to water or the land (expected mode and place of discharge)		
7.3	By deposition of pollutants emitted to air into the land or into water		
7.4	From any other sources		
7.5	Is there a risk of long term build up of pollutants in the environment from these sources?		

8. Risk of accidents during construction or operation of the Project, which could affect human health or the environment

S.No	Information/Checklist confirmation	Yes/No	Details thereof (with approximate quantities/rates, wherever possible) with source of information data
8.1	From explosions, spillages, fires etc from storage, handling, use or production of hazardous substances		
8.2	From any other causes		
8.3	Could the project be affected by natural disasters causing environmental damage (e.g. floods, earthquakes, landslides, cloudburst etc)?		

9. Factors which should be considered (such as consequential development) which could lead to environmental effects or the potential for cumulative impacts with other existing or planned activities in the locality

S. No.	Information/Checklist confirmation	Yes/No	Details thereof (with approximate quantities/rates, wherever possible) with source of information data
---------------	---	---------------	---

9.1	Lead to development of supporting facilities, ancillary development or development stimulated by the project which could have impact on the environment e.g.: <ul style="list-style-type: none"> ▪ Supporting infrastructure (roads, power supply, waste or waste water treatment, etc.) ▪ housing development ▪ extractive industries ▪ supply industries ▪ other 		
9.2	Lead to after-use of the site, which could have an impact on the environment		
9.3	Set a precedent for later developments		
9.4	Have cumulative effects due to proximity to other existing or planned projects with similar effects		

(III) Environmental Sensitivity

S.No.	Areas	Name/ Identity	Aerial distance (within 15 km.) Proposed project location boundary
1	Areas protected under international conventions, national or local legislation for their ecological, landscape, cultural or other related value		
2	Areas which are important or sensitive for ecological reasons - Wetlands, watercourses or other water bodies, coastal zone, biospheres, mountains, forests		
3	Areas used by protected, important or sensitive species of flora or fauna for breeding, nesting, foraging, resting, over wintering, migration		
4	Inland, coastal, marine or underground waters		
5	State, National boundaries		
6	Routes or facilities used by the public for access to recreation or other tourist, pilgrim areas		
7	Defence installations		
8	Densely populated or built-up area		
9	Areas occupied by sensitive man-made land uses (<i>hospitals, schools, places of worship,</i>		

	<i>community facilities)</i>		
10	Areas containing important, high quality or scarce resources (<i>ground water resources, surface resources, forestry, agriculture, fisheries, tourism, minerals</i>)		
11	Areas already subjected to pollution or environmental damage. (<i>those where existing legal environmental standards are exceeded</i>)		
12	Areas susceptible to natural hazard which could cause the project to present environmental problems (<i>earthquakes, subsidence, landslides, erosion, flooding or extreme or adverse climatic conditions</i>)		

(IV) PROPOSED TERMS OF REFERENCE FOR EIA STUDIES

“I hereby given undertaking that the data and information given in the application and enclosures are true to the best of my knowledge and belief and I am aware that if any part of the data and information submitted is found to be false or misleading at any stage, the project will be rejected and clearance give, if any to the project will be revoked at our risk and cost.

Date: _____

Place: _____

Signature of the applicant
With Name and Full Address
(Project Proponent / Authorized Signatory)

NOTE:

1. The projects involving clearance under Coastal Regulation Zone Notification, 1991 shall submit with the application a C.R.Z. map duly demarcated by one of the authorized agencies, showing the project activities, w.r.t. C.R.Z. (at the stage of TOR) and the recommendations of the State Coastal Zone Management Authority (at the stage of EC). Simultaneous action shall also be taken to obtain the requisite clearance under the provisions of the C.R.Z. Notification, 1991 for the activities to be located in the CRZ.
2. The projects to be located within 10 km of the National Parks, Sanctuaries, Biosphere Reserves, Migratory Corridors of Wild Animals, the project proponent shall submit the map duly authenticated by Chief Wildlife Warden showing these features vis-à-vis the project location and the recommendations or comments of the Chief Wildlife Warden thereon (at the stage of EC).”
3. All correspondence with the Ministry of Environment & Forests including submission of application for TOR/Environmental Clearance, subsequent clarifications, as may be required from time to time, participation in the EAC Meeting on behalf of the project proponent shall be made by the authorized signatory only. The authorized signatory should also submit a document in support of his claim of being an authorized signatory for the specific project.”

ANNEXURE IV
Critically Polluted Industrial Areas and Clusters/Potential Impact
Zones

**Table 1: Details of Critically Polluted Industrial Areas and Clusters / Potential Impact Zone
(Ref: Office Memorandum No. J-11013/5/2010-IA.II(I) Dated 13.1.2010)**

S. No.	Critically Polluted Industrial Area and CEPI	Industrial Clusters/ Potential Impact Zones
1.	Ankeshwar (Gujarat) CEPI-88.50(Ac_Wc_Lc)	<ul style="list-style-type: none"> ▪ GIDC Ankeshwar and GIDC, Panoli
2	Vapi (Gujarat) CEPI-88.09(Ac_Wc_Lc)	<ul style="list-style-type: none"> ▪ GIDC Vapi
3	Ghaziabad (Uttar Pradesh) CEPI-87.37(Ac_Wc_Lc)	<p>Sub-cluster A</p> <ul style="list-style-type: none"> ▪ Mohan nagar industrial area ▪ Rajinder nagar industrial area ▪ Sahibabad industrial area <p>Sub-cluster B</p> <ul style="list-style-type: none"> ▪ Pandav nagar industrial area ▪ Kavi nagar industrial area ▪ Bulandshahar road industrial area ▪ Amrit nagar ▪ Aryanagar industrial area <p>Sub-cluster C</p> <ul style="list-style-type: none"> ▪ Merrut road industrial are <p>Sub-cluster D</p> <ul style="list-style-type: none"> ▪ Loni industrial area ▪ Loni Road industrial area ▪ Roop nagar industrial area <p>Sub-cluster E</p> <ul style="list-style-type: none"> ▪ Hapur Road industrial area ▪ Dasna ▪ Philkura <p>Sub-cluster F (Other scattered industrial areas)</p> <ul style="list-style-type: none"> ▪ South side of GT road ▪ Kavi Nagar ▪ Tronica city ▪ Anand Nagar ▪ Jindal Nagar ▪ Prakash Nagar ▪ Rural industrial estate
4	Chandrapur (Maharashtra) CEPI-83.88 (Ac_Wc_Lc)	<ul style="list-style-type: none"> ▪ Chandrapur (MIDC Chandrapur, Tadali, Ghuggus, Ballapur)
5	Kobra (Chhatisgarh) CEPI-83.00 (Ac_Ws_Lc)	<ul style="list-style-type: none"> ▪ Industrial areas and their townships of NTPC, BALCO, CSEB (East) & CSEB (West) ▪ Korba town
6	Bhiwadi (Rajasthan) CEPI-82.91 (Ac_Wc_Ls)	<ul style="list-style-type: none"> ▪ RIICO industrial areas Phase I to IV ▪ Bhiwadi town ▪ Other surrounding industrial areas: Chopanki, Rampura Mundana, Khuskhera Phase I to III
7	Angul Talcer(Orissa) CEPI-82.09 (Ac_Wc_Lc)	<ul style="list-style-type: none"> ▪ MCL Coal mining area, Augul – Talcer region ▪ Industrial area (60 km x 45 km) <p>Following blocks of Augul district:</p> <ul style="list-style-type: none"> ▪ Kohina block ▪ Talcher block

		<ul style="list-style-type: none"> ▪ Angul block ▪ Chhendipada block ▪ Banarpal block ▪ Odapada block of Dhenkamal district
8	Vellore (North Arcot) (Tamil Nadu) CEPI-81.79 (Ac_Wc_Lc)	<ul style="list-style-type: none"> ▪ Ranipet, SIPCOT industrial complex
9	Singrauli (Uttar Pradesh) CEPI-81.73 (Ac_Wc_Ls)	<p>Sonebhadra (UP)</p> <ul style="list-style-type: none"> ▪ Dala-Tola ▪ Obra ▪ Renukoot ▪ Anpara ▪ Renusagar ▪ Kakri ▪ Dudhichuwa ▪ Bina ▪ Khadia ▪ Shakti nagar ▪ Rihand nagar ▪ Bijpur <p>Sigrauli (Madhya Pradesh)</p> <p>Vindhyachal nagar and Jaynat, Nigahi, Dudhichua, Amlohri & Jhingurdah townships</p>
10	Ludhiana (Punjab) CEPI-81.66 (Ac_Wc_Ls)	<p>Ludhiana municipal limits covering industrial clusters:</p> <ul style="list-style-type: none"> ▪ Focal point along with NH-I- Total eight phase ▪ Industrial area-B- from sherpur chowk to Gill road & Gill road to Miller Kotla road (left side of road) ▪ Mixed industrial area – right side of Gill road ▪ Industrial area –C (near Juglana village) ▪ Industrial area A & extension: area between old GT road and Ludhiana bypass road ▪ Industrial estate: near Dholwal chowk ▪ Mixes industrial area (MIA) Miller gunj ▪ MIA – bypass road ▪ Bahdur industrial area ▪ Tejpur industrial complex
11	Nazafgarh drain basin, Delhi CEPI-79.54 (As_Wc_Lc)	<ul style="list-style-type: none"> ▪ Industrial areas: Anand Parvat, Naraina, Okhla and Wazirpur
12	Noida (Uttar Pradesh) CEPI-78.90 (Ac_Wc_Lc)	<p>Territorial Jurisdiction of:</p> <ul style="list-style-type: none"> ▪ Noida Phase-1 ▪ Noida Phase-2 ▪ Noida Phase-3 ▪ Surajpur industrial area ▪ Greater Noida industrial area ▪ Village- Chhaparaula
13	Dhanbad (Jharkhand) CEPI-78.63 (Ac_Ws_Lc)	<p>Four blocks of Dhanbad district:</p> <ul style="list-style-type: none"> ▪ Sadar (Dhanbad Municipality) ▪ Jharia (Jharia Municipality, Sindri industrial area) ▪ Govindpur (Govindpur industrial estate) ▪ Nirsa
14	Dombivalli (Maharashtra) CEPI-78.41 (Ac_Wc_Ls)	<ul style="list-style-type: none"> ▪ MIDC Phase- I, Phase- II

15	Kanpur (Uttar Pradesh) CEPI-78.09 (Ac_Wc_Ls)	Industrial areas: <ul style="list-style-type: none"> ▪ Dada nagar ▪ Panki ▪ Fazalganj ▪ Vijay nagar ▪ Jajmau
16	Cuddalore (Tamil Nadu) CEPI-77.45 (As_Wc_Lc)	<ul style="list-style-type: none"> ▪ SIPCOT industrial complex, Phase I & II
17	Aurangabad (Maharashtra) CEPI-77.44 (Ac_Wc_Ls)	<ul style="list-style-type: none"> ▪ MIDC Chikhalthana, MIDC Waluj, MIDC Shendra, and Paithan road industrial area
18	Faridabad (Haryana) CEPI-77.07 (Ac_Ws_Lc)	<ul style="list-style-type: none"> ▪ Sector 27-A, B, C, D ▪ DLF phase- 1, sector 31,32 ▪ DLF phase- 2, sector 35 ▪ Sector 4, 6, 24, 27, 31, 59 ▪ Industrial area Hatin ▪ Industrial model township
19	Agra (Uttar Pradesh) CEPI-76.48 (As_Wc_Ls)	<ul style="list-style-type: none"> ▪ Nunihai industrial estate, Rambag nagar, UPSIDC industrial area, and Runukata industrial area
20	Manali (Tamil Nadu) CEPI-76.32 (Ac_Ws_Ls)	<ul style="list-style-type: none"> ▪ Manali industrial area
21	Haldia (West Bengal) CEPI-75.43 (As_Wc_Ls)	<ul style="list-style-type: none"> ▪ 5 km wide strip (17.4 x 5.0 km) of industrial area on the southern side of the confluence point of Rivers Hugli and Rupnarayan, covering ▪ Haldia municipal area & Sutahata block – I and II
22	Ahmedabad (Gujarat) CEPI-75.28 (Ac_Ws_Ls)	<ul style="list-style-type: none"> ▪ GIDC Odhav ▪ GIDC Naroda
23	Jodhpur (Rajasthan) CEPI-75.19 (As_Wc_Ls)	<ul style="list-style-type: none"> ▪ Industrial areas including Basni areas (phase-I & II), industrial estate, light & heavy industrial areas, industrial areas behind new power house, Mandore, Bornada, Sangariya and village Tanwada & Salawas. ▪ Jodhpur city
24	Greater Cochin (Kerala) CEPI-75.08 (As_Wc_Ls)	<ul style="list-style-type: none"> ▪ Eloor-Edayar industrial belt, ▪ Ambala Mogal industrial areas
25	Mandi Gobind Garh (Punjab) CEPI-75.08 (Ac_Ws_Lc)	<ul style="list-style-type: none"> ▪ Mandi Govindgarh municipal limit and khanna area
26	Howrah (West Bengal) CEPI-74.84 (As_Ws_Lc)	<ul style="list-style-type: none"> ▪ Liluah-Bamangachhi region, Howrah ▪ Jalan industrial complex-1, Howrah
27	Vatva (Gujarat) CEPI-74.77 (Ac_Wc_Ls)	<ul style="list-style-type: none"> ▪ GIDC Vatva, Narol industrial area (Villages Piplaj, Shahwadi, Narol)
28	Ib Valley (Orissa) CEPI-74.00 (Ac_Ws_Ls)	<ul style="list-style-type: none"> ▪ Ib Valley of Jharsuguda (Industrial and mining area)
29	Varansi-Mirzapur (Uttar Pradesh) CEPI-73.79 (As_Wc_Ls)	<ul style="list-style-type: none"> ▪ Industrial estate, Mirzapur ▪ Chunar ▪ Industrial estate, Chandpur, Varansi ▪ UPSIC, industrial estate, Phoolpur ▪ Industrial area, Ramnagar, Chandauli
30	Navi Mumbai (Maharashtra) CEPI-73.77 (Ac_Ws_Ls)	<ul style="list-style-type: none"> ▪ TTC industrial area, MIDC, Navi Mumbai (including Bocks-D, C, EL, A, R, General, Kalva)

31	Pali (Rajasthan) CEPI-73.73 (As_Wc_Ls)	<ul style="list-style-type: none"> ▪ Existing industrial areas: Mandia road, Puniyata road, Sumerpur ▪ Pali town
32	Mangalore (Karnataka) CEPI-73.68 (Ac_Ws_Ls)	<ul style="list-style-type: none"> ▪ Baikampady industrial area
33	Jharsuguda (Orissa) CEPI-73.34 (Ac_Ws_Ls)	<ul style="list-style-type: none"> ▪ Ib valley of Jharsuguda (Industrial and mining area)
34	Coimbatore (Tamil Nadu) CEPI-72.38 (Ac_Ws_Ln)	<ul style="list-style-type: none"> ▪ SIDCO, Kurichi industrial Clusters
35	Bhadravati (Karnataka) CEPI-72.33 (Ac_Ws_Ln)	<ul style="list-style-type: none"> ▪ KSSIDC Industrial area, Mysore paper mill & VISL township complex
36	Tarapur (Maharashtra) CEPI-72.01 (Ac_Ws_Ls)	<ul style="list-style-type: none"> ▪ MIDC Tarapur
37	Panipat (Haryana) CEPI-71.91 (As_Ws_Ls)	<ul style="list-style-type: none"> ▪ Panipat municipal limit and its industrial clusters
38	Indore (Madhya Pradesh) CEPI-71.26 (As_Ws_Ls)	<p>Following 09 industrial area:</p> <ul style="list-style-type: none"> ▪ Sanwer road ▪ Shivaji nagar ▪ Pologround ▪ Laxmibai nagar ▪ Scheme no.71 ▪ Navlakha ▪ Pipliya ▪ Palda ▪ Rau <p>Indore city</p> <p>Other surrounding industrial areas: Manglia, Rajoda, Asrawad, Tejpur Gadwadi</p>
39	Bhavnagar (Gujarat) CEPI-70.99 (As_Ws_Ls)	<ul style="list-style-type: none"> ▪ GIDI Chitra, Bhavnagar
40	Vishakhapatnam (Andhra Pradesh) CEPI-70.82 (As_Ws_Ls)	<ul style="list-style-type: none"> ▪ Bowl area (the area between Yarada hill range in the south to Simhachalam hill range in the north and sea on the east and the present NH-5 in the west direction)
41	Junagarh (Gujarat) CEPI-70.82 (As_Ws_Ls)	<p>Industrial areas:</p> <ul style="list-style-type: none"> ▪ Sabalpur ▪ Jay Bhavani ▪ Jay Bhuvneshwari ▪ GIDC Junagarh (I&II)
42	Asansole (West Bengal) CEPI-70.20 (As_Ws_Ls)	<ul style="list-style-type: none"> ▪ Bumpur area surrounding IISCO
43	Patancheru - Bollaram (Andhra Pradesh) CEPI-70.07 (As_Ws_Ls)	<p>Industrial area:</p> <ul style="list-style-type: none"> ▪ Patancheru ▪ Bollaram

Note:

Names of identified industrial clusters/potential impact zones are approximate location based on rapid survey and assessment and may alter partially subject to the detailed field study and monitoring. Detailed mapping will be made available showing spatial boundaries of the identified industrial clusters including zone of influence/ buffer zone, after in depth field study.

ANNEXURE V
Pre-Feasibility Report: Points for Possible Coverage

Table: Points for Possible Coverage in Pre-feasibility Report

S. No.	Contents	Points of Coverage in Pre-feasibility Report
I.	Executive summary	<ul style="list-style-type: none"> ▪ A miniature report of entire pre feasibility report.
II.	Project Details	
	Need/Justification of the Project	<ul style="list-style-type: none"> ▪ Current demand scenario of the product ▪ Alternatives to meet the demand ▪ Post project scenario on residual demand
	Capacity of Induction/Arc Furnace/ Cupola Furnace Plant	<ul style="list-style-type: none"> ▪ Production capacity of the industry ▪ Sustainability of raw material supply and quality ▪ Optimization of plant capacity
	Process technology	<ul style="list-style-type: none"> ▪ Analysis of available/advanced technologies, etc. ▪ Analysis of possible configurations for each technology or a combination of these technologies ▪ Broad specifications for the proposed industrial units and process technologies/equipments
	Resources/raw materials	<ul style="list-style-type: none"> ▪ Details on raw material, by products ▪ Water <ul style="list-style-type: none"> ▪ Water requirement for process, utilities, domestic, gardening etc. ▪ Source of construction water and potable water ▪ Source of circulating/consumptive water ▪ Quality of raw water, treated water ▪ Water budget calculations and effluent generation ▪ Approved water allocation quota (drinking, irrigation and industrial use) and surplus availability ▪ Feasible ways of bringing water to site indicating constraints if any. ▪ Lean season water availability and allocation source in case main source not perennial. ▪ Manpower ▪ Infrastructure ▪ Electrical power ▪ Construction material like sand, brick, stone chips, borrow earth etc.
	Rejects (Pollution potential)	<ul style="list-style-type: none"> ▪ Air emissions (VOCs, HAPs, Dioxins and furans, metals, Chlorides and fluorides, etc.) ▪ Water pollution ▪ Solid / hazardous waste (slag, steel skulls, waste refractories, sludge, etc.) ▪ Noise ▪ Odour
	Technical profile	<ul style="list-style-type: none"> ▪ Construction details ▪ Estimated duration ▪ Number of construction workers including migrating workers ▪ Construction equipment ▪ Vehicular traffic ▪ Source, mode of transportation and storage of construction material ▪ Traffic that would arise during different phases of the project and transportation mechanism to handle such traffic ▪ New facilities needed ▪ Technical parameters of the plant & equipments to be

		<ul style="list-style-type: none"> used ▪ Product storage and associated transportation system ▪ Product demand & supply position data on regional basis
	Project schedule	<ul style="list-style-type: none"> ▪ Project implementation schedule
	Future prospects	<ul style="list-style-type: none"> ▪ Ascertain the costs and benefits of the proposed project for project life ▪ Technical and logistic constraints/ requirements of project sustainability
III.	Selection of site based on least possible impacts	
i.	▪ Choice of site selection	
	Major techno-economic feasibility considerations	<ul style="list-style-type: none"> ▪ Land availability & its development ▪ Product demand around the selected site ▪ Access to site for transportation of equipments/ construction machinery, material, <i>etc.</i> ▪ Raw material availability and its transportation ▪ Water availability and consumptive use ▪ Product transportation ▪ Infrastructure availability at selected site ▪ Inter-state issue, if any
	Incompatible landuse and ecologically sensitive attributes with respect to identified suitable sites	<ul style="list-style-type: none"> ▪ If any incompatible land-use attributes fall within the study area, the following details has to be provided: ▪ Public water supply areas from rivers/surface water bodies, from groundwater ▪ Scenic areas/tourism areas/hill resorts ▪ Religious places, pilgrim centers that attract over 10 lakh pilgrims a year ▪ Protected tribal settlements (notified tribal areas where industrial activity is not permitted); CRZ ▪ Monuments of national significance, World Heritage Sites ▪ Cyclone, Tsunami prone areas (based on last 25 years); ▪ Airport areas ▪ Any other feature as specified by the State or local government and other features as locally applicable, including prime agricultural lands, pastures, migratory corridors, <i>etc.</i> ▪ If ecologically sensitive attributes fall within the study area, please give details. Ecologically sensitive attributes include ▪ National parks ▪ Wild life sanctuaries Game reserve ▪ Tiger reserve/elephant reserve/turtle nesting ground ▪ Mangrove area ▪ Wetlands ▪ Reserved and protected forests ▪ Endangered species of flora and fauna ▪ Any other eco – sensitive areas <i>etc.</i>
	Social aspects	<ul style="list-style-type: none"> ▪ Corporate social responsibilities ▪ Employments and infrastructure added in the vicinity of the plant ▪ Status of land availability, current and post project land use variation ▪ Social sensitivity and likely project affected people
ii.	Details of selected site	
	Land details	<ul style="list-style-type: none"> ▪ Land requirement and availability

		<ul style="list-style-type: none"> ▪ Land ownership details such as Government, private, tribal, non-tribal, etc. ▪ Total area of the project/site ▪ Prevailing land cost details
	Location	<ul style="list-style-type: none"> ▪ Geographical details - Longitude & latitude, village, taluka, district, state ▪ Approach to site – roads, railways and airports ▪ Distance from nearest residential and industrial areas ▪ Distance from nearest water bodies such as river, canal, dam, etc ▪ Distance from ecologically sensitive areas ▪ In case of flood prone areas, HFL of the site ▪ In case of seismic areas, seismic zone, active faults, occurrence on earthquakes, etc. ▪ Proximity from infrastructural facilities
	Physical characteristics	<ul style="list-style-type: none"> ▪ Demography ▪ Meteorological data ▪ Landuse pattern such as agricultural, barren, forest, <i>etc.</i> and details thereof ▪ Topography of the area ▪ Drainage patterns ▪ Soil condition and soil investigation results ▪ Ground profile and levels
IV.	Anticipated impacts based on project operations on receiving environment	<ul style="list-style-type: none"> ▪ Population ▪ Flora and fauna ▪ Water ▪ Soil ▪ Air ▪ Climate ▪ Landscape, <i>etc.</i>
V.	Proposed broad mitigation measures which could effectively be internalized as project components to have environmental and social acceptance of the proposed site	<ul style="list-style-type: none"> ▪ Preventive measures ▪ Source control measures ▪ Mitigation measures at the receiving environment, ▪ Health and safety measures, <i>etc.</i>
VI.	An indication of any difficulties (technical deficiencies or lack of know-how) encountered by the developer in compiling the required information.	

The above listing is not exhaustive. Thus the proponent may provide additional necessary information, felt appropriate, to include in the pre-feasibility study report in support of selecting the site for the proposed developmental activities. The Concerned EAC/SEAC during scrutiny, may specifically ask for any additional information/data required to substantiate the requirement to prescribe the ToR for EIA studies. However, it is to make clear that all the required further information by EAC/SEAC may be mentioned in one single letter, within the prescribed time.

ANNEXURE VI
Types of Monitoring and Network Design Considerations

TYPES OF MONITORING AND NETWORK DESIGN CONSIDERATIONS

A. Types of Monitoring

Monitoring refers to the collection of data using a series of repetitive measurements of environmental parameters (or, more generally, to a process of systematic observation). The environmental quality monitoring programme design will be dependent upon the monitoring objectives specified for the selected area of interest. The main types of EIA monitoring activities are:

- Baseline monitoring is the measurement of environmental parameters during the pre-project period for the purpose of determining the range of variation of the system and establishing reference points against which changes can be measured. This leads to the assessment of the possible (additional available) assimilative capacity of the environmental components in pre-project period w.r.t. the standard or target level.
- Effects monitoring is the measurement of environmental parameters during project construction and implementation to detect changes which are attributable to the project to provide the necessary information to:
 - verify the accuracy of EIA predictions; and
 - determine the effectiveness of measures to mitigate adverse effects of projects on the environment.
 - Feedback from environmental effect monitoring programs may be used to improve the predictive capability of EIAs and also determine whether more or less stringent mitigation measures are needed
- Compliance monitoring is the periodic sampling or continuous measurement of environmental parameters to ensure that regulatory requirements and standards are being met.

Compliance and effects monitoring occurs during the project construction, operation, and abandonment stages. The resources and institutional set-up should be available for the monitoring at these stages. All large-scale construction projects will require some construction stage monitoring. To control the environmental hazards of construction as specified in the EIA, a monitoring program should be established to ensure that each mitigation measure is effectively implemented. There are numerous potential areas for monitoring during operations. It is meaningful to perform baseline monitoring at those stations where the effects monitoring is to be performed so that the change from baseline due to the project as predicted by models can be validated and rectification can be performed even after the project starts functioning. It is therefore necessary to select the base line stations at those places where the predicted effects will be very high.

The scope of monitoring topics discussed in this chapter is limited to Baseline and Effects monitoring. In addition, this chapter will also discuss the Compliance monitoring during the construction phase. Post-project monitoring requirements are discussed in the EMP.

Before any field monitoring tasks are undertaken there are many institutional, scientific, and fiscal issues that must be addressed in the implementation of an environmental monitoring program. Careful consideration of these issues in the design and planning stages will help avoid many of the pitfalls associated with environmental monitoring programs. Although these issues are important but the discussions here are confined to the monitoring network design component.

B. Network Design

Analysis of Significant Environmental Issues

At the outset of planning for an environmental monitoring network, the EIA manager may not know exactly what should be monitored, when monitoring should begin, where it should monitor, which techniques should be employed, and who should take responsibility for its conduct. Because there are usually a number of objective decisions associated with network design to be made, it is important to start with an analysis of environmental issues. The scoping phase of an EIA is designed to identify and focus on the major issues. Scoping should provide a valuable source of information on the concerns that need to be addressed by the monitoring network design. These are project specific as well as specific to the environmental setting of the location where the project is proposed to be located

Hence, the network designs are associated with questions like:

- What are the expected outputs of the monitoring activity?
- Which problems do we need to address to? *etc.*

Defining the output will influence the design of the network and optimize the resources used for monitoring. It will also ensure that the network is specially designed to optimize the information on the problems at hand

What to Monitor?

The question of what to monitor is associated with the identification of VECs.

VECs are generally defined as environmental attributes or components of the environment that are valued by society as identified during the scoping stage of the project. They are determined on the basis of perceived public concerns. For example, changes to water quality and quantity could have implications on fish by affecting habitat, food supply, oxygen, and contaminant uptake. Similarly, employment and business, and economies are both VECs that serve as pathways.

The choice of VECs is also related to the perceived significant impact of the project implementation on important environmental components. In general, the significance or importance of environmental components is judged based on:

- legal protection provided (for example, rare and endangered species)
- political or public concerns (for example, resource use conflicts and sustainable development)
- scientific judgment (for example, ecological importance); or
- commercial or economic importance

However, in addition to their economic, social, political or ecological significance, the chosen VEC should also have unambiguous operational ease, be accessible to prediction and measurement; and be susceptible to hazard. Once the VECs are defined, the VECs may be directly measured (for example, extent of habitat for an endangered species). In cases where it is impossible or impractical to directly measure the VECs, the chosen measurement endpoints or environmental indicators must correspond to, or be predictive of assessment endpoints.

The chosen environmental indicators must be: 1) measurable; 2) appropriate to the scale of disturbance/ contamination; 3) appropriate to the impact mechanism; 4) appropriate and proportional to temporal dynamics; 5) diagnostic; and 6) standardized; as well as have: 1) a low natural variability; 2) a broad applicability; and 3) an existing data series.

C. Site Selection

This normally means that for designing a monitoring programme in an (study) area which might have an impact, several monitoring stations are needed for characterizing the baseline conditions of the impacted area. When considering the location of individual samplers, it is essential that the data collected are representative for the location and type of area without the undue influence from the immediate surroundings. In any measurement point in the study area the total ambient concentration is the representative of:

- natural background concentration
- regional background
- impact of existing large regional sources such as Industrial emissions

To obtain the information about the importance of these different contributions it is therefore necessary to locate monitoring stations so that they are representative for different impacts. In addition to the ambient pollution data, one would often need other data governing the variations such as meteorological data for air pollution, to identify and quantify the sources contributing to the measurements. When considering the location of individual samplers, it is essential that the data collected are representative for the location and type of area without undue influence from the immediate surroundings. For example, for measuring natural background concentration, if a dust sampler is located adjacent to a dusty road at road level, this will read occasional traffic pollution rather than the general background dust level of the area. As such a proper QA/QC must be followed to locate stations. USEPA guidelines are available for this.

Where, How and How Many Times to Monitor?

These are the other components of Monitoring Network Design. These questions are best answered based on local field conditions, capacity and resources available, prevailing legal and regulatory priorities, *etc.* For this screening or reconnaissance Surveys of the study area also necessary. This may also include some simple inexpensive measurements and assimilative/dispersion modeling. The data will give some information on the prevailing spatial and temporal variations, and the general background air pollution in the area. The number of monitoring stations and the indicators to be measured at each station in the final permanent network may then be decided upon based on the results of the screening study as well as on the knowledge of the sources of the proposed development and prevailing local environmental/meteorological conditions. The best possible definition of the air pollution problem, together with the analysis of the resources: personnel, budget and equipment available, represent the basis for the decision on the following questions:

- What spatial density (number) of sampling stations is required?

It is evident that the more is the number of stations selected in the study area, the more representative is the data and the more is the cost of monitoring. Therefore this needs optimization. For example, for optimum results as per the present practice, for medium sized plants like a stand alone induction and electric arc furnace, submerged arc furnace and cupola, the study area is a circle of 10 km radius from the plant centre; the number of AAQ stations are at least 6; the number of meteorological station may be 1 in case the study area falls in a single air shed having similar meteorological conditions and more in

case the study area falls in more than one air sheds; the number of surface water quality stations will depend on the number of surface water bodies present in the study area and likely to get polluted; the number of ground water stations may be at least 6 to 8; the number of noise monitoring stations will depend upon the number of residential, commercial and sensitive areas likely to get affected due to the noise from the plant operation and its services facilities like transport; the number of soil monitoring stations will be those agricultural lands where the dust fall from the plant is likely to be high; the number of ecological monitoring stations will depend upon the number of ecologically sensitive spots etc. Qualitative and quantitative models may be used to defend the decision. However, these optimum figures are not statutory requirements and may change from time to time as more scientific and credible information becomes available. These must be presented in the ToR before costly monitoring exercise is started to save repetitions. For details refer Annexure 4.

- How many samples are needed and during what period (sampling (averaging) time and frequency)?

These are mostly governed by statutory stipulations made in the E(P) Act/ EIA Notification/ EIA questionnaire. These must be presented in the ToR before costly monitoring exercise is started to save repetitions. Generally, the sampling averaging time must be compatible with the norms e.g., 24 hrs average for AAQ for PM₁₀/PM_{2.5}/SO₂/NO₂/Pb/NH₃ and 1hr. for O/CO twice a week for at least one full season of 3 months except monsoon equally spaced. Annual base line data for Benzene/Benzo(A)Pyrene/As and Ni as needed in the new AAQ monitoring notification may not be possible at EIA stage and hence must be collected from secondary data if available or during compliance monitoring. Met data should be hourly to be compatible with dispersion models. Water samples should be grab or composite for flowing water collected over the sampling period of one full season and ground water for pre and post monsoon to give more representative data. LEQ noise should be collected on limited days over 24 hours to obtain night time and day time values. Dust fall should be collected monthly for 3 months of monitoring period. As work zone, stack, ecological and socio economic monitoring are not much season oriented, they may be collected at the earliest. For details refer Annexure 4.

- Where should the stations be located?

As described, the location should be the worst affected areas due to plant operation. As such for AAQ monitoring, a qualitative or quantitative screening model may be used to identify inhabited localities/ sensitive locations/ areas under surveillance with limited met and emission data where GLC due to plant operation will be very high; for surface water monitoring all static water bodies, upstream and down stream of flowing water bodies from locations of probable discharges; all upstream and downstream ground water bodies from probable locations of leaching possibilities (for this ground water contours of the area should be pre determined); all ecologically sensitive areas; residential/commercial/sensitive locations for noise monitoring; prime agricultural lands for dust fall monitoring etc. In general, there must be a scientific basis for selecting locations. These must be presented in the ToR before costly monitoring exercise is started to save repetitions. For details refer Annexure 4.

- What kind of equipment should be used?

The CPCB guidelines describe such equipment and methods in details. In addition, standard literatures/ handbooks like USEPA/APHA handbooks may be referred. For details refer Annexure 4.

- What additional background information is needed?
 - Published meteorological data from IMD's nearest station

- topography from Survey of India/ satellite imageries
 - population density from latest government publications
 - emission sources and emission rates of plant proper/ other nearby plants affecting study area
 - effects and impacts
 - ground water contours
 - data on forest and ecology from forest department
 - upper air data- primary or secondary
 - any other secondary information
- How will the data be made available/communicated?

All raw data must be preserved. Adequate QA/QC may be followed. Summary data may be included in the EIA.

ANNEXURE VII
Guidance for Assessment of Baseline Components and Attributes

GUIDANCE FOR ASSESSMENT OF BASELINE COMPONENTS AND ATTRIBUTES*

Attributes	Sampling		Measurement Method	Remarks
	Network	Frequency		
A. Air				
<ul style="list-style-type: none"> ▪ Meteorological ▪ Wind speed ▪ Wind direction ▪ Dry bulb temperature ▪ Wet bulb temperature ▪ Relative humidity ▪ Rainfall ▪ Solar radiation ▪ Cloud cover 	<p>Minimum 1 site in the project impact area requirements</p> <p>Other additional site(s) are require depending upon the model applied or site sensitivities</p>	<p>Min: 1 hrly observations from continuous records</p>	<p>Mechanical / automatic weather station</p> <p>Rain gauge</p> <p>As per IMD</p> <p>As per IMD</p>	<p>IS 5182 Part 1-20 Sit-specific primary data is essential</p> <p>Secondary data from IMD, New Delhi for the nearest IMD station</p>
<p>Pollutants</p> <ul style="list-style-type: none"> ▪ PM₁₀ ▪ PM_{2.5} ▪ SO₂ ▪ NO₂ ▪ Pb ▪ NH₃ ▪ CO ▪ O ▪ Benzene ▪ BaP ▪ As ▪ Ni ▪ H₂S* ▪ HC* ▪ Fluoride* ▪ VOC-PAH* 	<p>10 to 15 locations in the project impact area</p>	<p>24 hrly twice a week</p> <p>1 hrly twice a week</p> <p>Annual</p> <p>24 hrly twice a week</p>	<ul style="list-style-type: none"> ▪ Gravimetric (High – Volume with Cyclone) ▪ EPA Modified West & Gaeke method ▪ Ultraviolet fluorescence ▪ Chemiluminescence ▪ TAEM ▪ Beta attenuation ▪ Arsenite Modified Jacob & Hochheiser ▪ NDIR technique ▪ AAS/ICP ▪ ED-XRF ▪ GC ▪ Methylene-blue ▪ Nessler’s Method ▪ Infra Red analyzer ▪ Specific Ion meter 	<p>Monitoring Network</p> <ul style="list-style-type: none"> ▪ Minimum 2 locations in upwind side, more sites in downwind side / impact zone ▪ All the sensitive receptors need to be covered <p>Parameters/Frequency/Measurement Methods</p> <p>As per CPCB standards for NAQM, 1994/ GSR826E dt. Nov. 16, 2009</p>

Attributes	Sampling		Measurement Method	Remarks
	Network	Frequency		
<ul style="list-style-type: none"> ▪ Mercury* (Parametres are given in GSR826E dt. Nov. 16, 2009/ToR for EIA studies based on nature of project, raw material & process technology, location-nature/activities within of air)				
B. Noise				
Hourly equivalent noise levels	Same as for Air Pollution along with others Identified in study area	At least one day continuous in each season on a working and non-working day	Instrument : Sensitive Noise level meter (preferably recording type)	Min: IS: 4954- 1968 as adopted by CPCB
Hourly equivalent noise levels	Inplant (1.5 m from machinery or high emission processes)	Same as above for day and night	Instrument : Noise level metre	CPCB / OSHA
Hourly equivalent noise levels	Highways (within 500 metres from the road edge)	Same as above for day and night	Instrument : Noise level meter	CPCB / IS : 4954-1968
C. Water				
Parameters for water quality <ul style="list-style-type: none"> ▪ Ph, temp, turbidity, magnesium hardness, total alkalinity, chloride, sulphate, nitrate, fluoride, sodium, potassium salinity ▪ Total nitrogen, total phosphorus, DO, BOD, COD, Phenol ▪ Heavy metals ▪ Total coliforms, faecal coliforms ▪ Phyto plankton ▪ Zooplankton ▪ Fish & other aquatic flora & 	Set of grab samples during pre and post- monsoon for ground and during monitoring season for surface water for the whole study zone. For lab. Analysis the samples should be preserved for transport safe	Diurnal and season-wise	Samples for water quality should be collected and analyzed as per: IS: 2488 (Part 1-5) methods for sampling and testing of industrial effluents Standard methods for examination of water and waste water analysis published by American Public Health Association. International standard practices for benthos and aquatic flora & fauna	

Attributes	Sampling		Measurement Method	Remarks
	Network	Frequency		
fauna (parameters are given in ToR for EIA studies based on nature of project, raw material & process technology, location-nature/activities within of air basin)				
For Surface Water Bodies				
<ul style="list-style-type: none"> ▪ Total Carbon ▪ PH ▪ Dissolved Oxygen ▪ Biological Oxygen ▪ Demand ▪ Free NH₄ ▪ Boron ▪ Sodium Absorption ratio ▪ Electrical Conductivity 	<p>Monitoring locations should include up-stream, on site, down stream of proposed discharge point. Besides sampling should cover width of the river in case water quality modeling is proposed.</p> <p>Standard methodology for collection of surface water (BIS standards)</p> <p>At least one grab sample per location per season</p>	<p>Yield & impact on water sources to be measured during critical season</p> <p>River Stretch within project area be divided in grids (say 1 km length and 1/3 width) and samples should be from each grid at a time when the wastewater discharged by other sources of pollution is expected to be maximum</p>	<p>Samples for water quality should be collected and analyzed as per:</p> <p>IS: 2488 (Part 1-5) methods for sampling and testing of industrial effluents</p> <p>Standard methods for examination of water and wastewater analysis published by American Public Health Association.</p>	<p>Historical data should be collected from relevant offices such as central water commission, state and central ground water board, Irrigation dept.</p>
Parameters for wastewater characterization				
<ul style="list-style-type: none"> ▪ Temp, colour, odour, turbidity, TSS, TDS ▪ PH , alkalinity as CaCO₃, p value, M value, total hardness as CaCO₃, chloride as cl, sulphate as SO₄, Nitrate as NO₃, Floride as F, Phosphate as PO₄, Chromium as Cr (Hexavalent, total) Ammonical Nitrogen as N, TKN, % sodium, BOD at 20 C, COD, DO, total residual chlorine as Cl₂, oil and grease, 	<p>Implant Source depending upon the different waste streams the parameters can be optimized</p> <p>Grab and composite sampling representing avg of different process operations as well as worst emission scenario should be represented</p>	<p>Different operational cycles as well as raw material variations should be reflected in the analysis</p>	<p>Samples for water quality should be collected and analyzed as per:</p> <p>IS: 2488 (Part 1-5) methods for sampling and testing of industrial effluents</p> <p>Standard methods for examination of water and wastewater analysis published by American Public Health Association.</p>	<p>All plant sources categorized as:</p> <ul style="list-style-type: none"> ▪ Different Process waste streams as well as run-off conditions ▪ ETP wastewater <p>Domestic/ sanitary wastewater</p>

Attributes	Sampling		Measurement Method	Remarks
	Network	Frequency		
sulphide, phenolic compound				
D. Land Environment				
<ul style="list-style-type: none"> ▪ Soil ▪ Particle size distribution ▪ Texture ▪ pH ▪ Electrical conductivity ▪ Caution exchange capacity ▪ Alkali metals ▪ Sodium Absorption Ratio (SAR) ▪ Permeability ▪ Porosity 	One surface sample from each landfill and/or hazardous waste site (if applicable) and prime villages, (soil samples be collected as per BIS specifications) in the study area	Season-wise	Collected and analyzed as per soil analysis reference books	The purpose of impact assessment on soil (land environment) is to assess the significant impacts due to leaching of wastes or accidental releases and contaminating
Land use / Landscape				
<ul style="list-style-type: none"> ▪ Location code ▪ Total project area ▪ Topography ▪ Drainage (natural) ▪ Cultivated, forest plantations, water bodies, roads and settlements 	At least 20 points along with plant boundary and general major land use categories in the study area.	Drainage once in the study period and land use categories from secondary data (local maps) and satellite imageries	<ul style="list-style-type: none"> ▪ Global positioning system ▪ Topo-sheets ▪ Satellite Imageries (1:25,000) ▪ Satellite Imageries (1:25,000) 	<p>Drainage within the plant area and surrounding is very important for storm water impacts.</p> <p>From land use maps sensitive receptors (forests, parks, mangroves etc.) can be identified</p>
E. Solid Waste				
<p>Quantity:</p> <ul style="list-style-type: none"> ▪ Based on waste generated from per unit production ▪ Per capita contribution ▪ Collection, transport and disposal system ▪ Process waste 		Process wise or activity wise for respective raw material used. Domestic waste depends upon the season also	<p>Guidelines</p> <p>IS 9569 : 1980</p> <p>IS 10447 : 1983</p> <p>IS 12625 : 1989</p> <p>IS 12647 : 1989</p> <p>IS 12662 (PTI) 1989</p>	

Attributes	Sampling		Measurement Method	Remarks
	Network	Frequency		
<ul style="list-style-type: none"> ▪ Quality (oily, chemical, biological) 				
Quality: <ul style="list-style-type: none"> ▪ General segregation into biological/organic/inert/hazardous ▪ Loss on heating ▪ pH ▪ Electrical Conductivity ▪ Calorific value, metals etc. 	For green field unites it is based on secondary data base of earlier plants. Grab and Composite samples	Process wise or activity wise for respective raw material used. Domestic waste depends upon the season also	Analysis IS 9334 : 1979 IS 9235 : 1979 IS 10158 : 1982	
Hazardous Waste				
<ul style="list-style-type: none"> ▪ Permeability And porosity ▪ Moisture pH ▪ Electrical conductivity ▪ Loss on ignition ▪ Phosphorous ▪ Total nitrogen ▪ Caution exchange capacity ▪ Particle size distribution ▪ Heavy metal ▪ Ansonia ▪ Fluoride 	For green field unites it is based on secondary data base of earlier plants Grab and Composite samples. Recyclable components have to analyzed for the recycling requirements	Process wise or activity wise for respective raw material used.	Analysis IS 9334 : 1979 IS 9235 : 1979 IS 10158 : 1982	Impacts of hazardous waste should be performed critically depending on the waste characteristics and place of discharge. For land disposal the guidelines should be followed and impacts of accidental releases should be assessed
F. Biological Environment Aquatic				
<ul style="list-style-type: none"> ▪ Primary productivity ▪ Aquatic weeds ▪ Enumeration of phytoplankton, zooplankton and benthos ▪ Fisheries ▪ Diversity indices 	Considering probable impact, sampling points and number of samples to be decided on established guidelines on ecological studies based on site eco-environment setting within 10/25 km radius from the	Season changes are very important	Standards techniques (APHA et. Al. 1995, Rau and Wooten 1980) to be followed for sampling and measurement	Seasonal sampling for aquatic biota One season for terrestrial biota, in addition to vegetation studies during monsoon season Preliminary assessment Microscopic analysis of plankton and meiobenthos, studies of macrofauna, aquatic vegetation and application of

Attributes	Sampling		Measurement Method	Remarks
	Network	Frequency		
<ul style="list-style-type: none"> ▪ Trophic levels ▪ Rare and endangered species ▪ Sanctuaries / closed areas / Coastal regulation zone (CRZ) ▪ Terrestrial ▪ Vegetation – species, list, economic importance, forest produce, medicinal value ▪ Importance value index (IVI) of trees ▪ Wild animals 	<p>proposed site</p> <p>Samples to collect from upstream and downstream of discharge point, nearby tributaries at down stream, and also from dug wells close to activity site</p>			<p>indices, viz. Shannon, similarity, dominance IVI etc</p> <p>Point quarter plot-less method (random sampling) for terrestrial vegetation survey.</p>
<p>Avifauna</p> <ul style="list-style-type: none"> ▪ Rare and endangered species ▪ Sanctuaries / National park / Biosphere reserve 	<p>For forest studies, chronic as well as short-term impacts should be analyzed warranting data on micro climate conditions</p>			<p>Secondary data to collect from Government offices, NGOs, published literature</p> <p>Plankton net</p> <p>Sediment dredge</p> <p>Depth sampler</p> <p>Microscope</p> <p>Field binocular</p>
G. Socio Economic				
<ul style="list-style-type: none"> ▪ Demographic structure ▪ Infrastructure resource base ▪ Economic resource base ▪ Health status: Morbidity pattern ▪ Cultural and aesthetic attributes 	<p>Socio-economic survey is based on proportionate, stratified and random sampling method</p>	<p>Different impacts occurs during construction and operational phases of the project</p>	<p>Primary data collection through R&R surveys (if require) or community survey are based on personal interviews and questionnaire</p>	<p>Secondary data from census records, statistical hard books, toposheets, health records and relevant official records available with Govt. agencies</p>

* Project Specific concerned parameters needs to be identified by the project proponent and shall be incorporated in the draft ToR, to be submitted to the Authority for the consideration and approval by the EAC/SEAC.

ANNEXURE VIII
Sources of Secondary Data

Annexure VIIIA: Potential Sources of Data For EIA

Information	Source
Air Environment	
1. Meteorology- Temperature, Rainfall, Humidity, Inversion, Seasonal Wind rose pattern (16 point compass scale), cloud cover, wind speed, wind direction, stability, mixing depth	<ul style="list-style-type: none"> ⊗ Indian Meteorology Department, Pune
2. Ambient Air Quality- 24 hourly concentration of SPM, RPM, SO ₂ , NO _x , CO	<ul style="list-style-type: none"> ⊗ Central Pollution Control Board (CPCB), ⊗ State Pollution Control Board (SPCB), ⊗ Municipal Corporations ⊗ Ministry of Environment and Forests (MoEF) ⊗ State Department of Environment (DoEN)
Water Environment	
3. Surface water- water sources, water flow (lean season), water quality, water usage, Downstream water users Command area development plan Catchment treatment plan	<ul style="list-style-type: none"> ⊗ Central Water Commission (CWC), ⊗ Central Pollution Control Board (CPCB), ⊗ State Pollution Control Board (SPCB), Central Water and Power Research Institute (CWPRS), Pune ⊗ State Irrigation Department ⊗ Hydel Power generation organizations such as NHPC, State SEBs
4. Ground Water- groundwater recharge rate/withdrawal rate, ground water potential groundwater levels (pre monsoon, post monsoon), ground water quality, changes observed in quality and quantity of ground water in last 15 years	<ul style="list-style-type: none"> ⊗ Central Ground Water Board (CGWB) ⊗ Central Ground Water Authority (CGWA) ⊗ State Ground Water Board (SGWB) ⊗ National Water Development Authority (NWDA)
5. Coastal waters- water quality, tide and current data, bathymetry	<ul style="list-style-type: none"> ⊗ Department of Ocean Development, New Delhi ⊗ State Maritime Boards ⊗ Naval Hydrographer's Office, Dehradun ⊗ Port Authorities ⊗ National Institute of Oceanography (NIO), Goa
Biological Environment	
6. Description of Biological Environment- inventory of flora and fauna in 7 km radius, endemic species, endangered species, Aquatic Fauna, Forest land, forest type and density of vegetation, biosphere, national parks, wild life sanctuaries, tiger reserve, elephant reserve, turtle nesting ground, core zone of biosphere reserve, habitat of migratory birds, routes of migratory birds	<ul style="list-style-type: none"> ⊗ District Gazetteers ⊗ National Remote Sensing Agency (NRSA), Hyderabad ⊗ Forest Survey of India, Dehradun ⊗ Wildlife Institute of India ⊗ World Wildlife Fund ⊗ Zoological Survey of India ⊗ Botanical Survey of India ⊗ Bombay Natural History Society, (BNHS), Mumbai ⊗ State Forest Departments ⊗ State Fisheries Department ⊗ Ministry of Environment and Forests ⊗ State Agriculture Departments ⊗ State Agriculture Universities
Land Environment	
7. Geographical Information-Latitude, Longitude, Elevation (above MSL)	<ul style="list-style-type: none"> ⊗ Toposheets of Survey of India, Pune ⊗ National Remote Sensing Agency (NRSA), Hyderabad ⊗ Space Application Centre (SAC), Ahmedabad

Information	Source
8. Nature of Terrain, topography map indicating contours (1:2500 scale)	<ul style="list-style-type: none"> ⊗ Survey of India Toposheets ⊗ National Remote Sensing Agency (NRSA), Hyderabad ⊗ State Remote Sensing Centre, ⊗ Space Application Centre (SAC), Ahmedabad
9. Hydrogeology- Hydrogeological report (in case of ground water is used/area is drought prone/wastewater is likely to discharged on land) Geomorphological analysis (topography and drainage pattern) Geological analysis (Geological Formations/Disturbances- geological and structural maps, geomorphological contour maps, structural features, including lineaments, fractures, faults and joints) Hydrogeological analysis (disposition of permeable formations, surface-ground water links, hydraulic parameter determination etc) Analysis of the natural soil and water to assess pollutant absorption capacity	<ul style="list-style-type: none"> ⊗ NRSA, Hyderabad ⊗ Survey of India Toposheets ⊗ Geological Survey of India ⊗ State Geology Departments ⊗ State Irrigation Department ⊗ Department of Wasteland Development, Ministry of Rural Areas ⊗ National Water Development Authority (NWDA)
10. Nature of Soil, permeability, erodibility classification of the land	<ul style="list-style-type: none"> ⊗ Agriculture Universities ⊗ State Agriculture Department ⊗ Indian Council for Agriculture Research ⊗ State Soil Conservation Departments ⊗ National Bureau of Soil Survey and Landuse Planning ⊗ Central Arid Zone Research Institute (CAZRI), Jodhpur
11. Landuse in the project area and 10 km radius of the periphery of the project	<ul style="list-style-type: none"> ⊗ Survey of India- Toposheets ⊗ All India Soil and Landuse Survey; Delhi ⊗ National Remote Sensing Agency (NRSA), Hyderabad ⊗ Town and County Planning Organisation ⊗ State Urban Planning Department ⊗ Regional Planning Authorities (existing and proposed plans) ⊗ Village Revenue Map- District Collectorate ⊗ Directorate of Economics and Statistics-State Government ⊗ Space Application Centre, Ahmedabad
12. Coastal Regulation Zones- CRZMP, CRZ classification, Demarcation of HTL and LTL*	<ul style="list-style-type: none"> ⊗ Urban Development Department ⊗ State Department of Environment ⊗ State Pollution Control Board ⊗ Space Application Centre* ⊗ Centre for Earth Sciences Studies, Thiruvanthapuram* ⊗ Institute of Remote Sensing, Anna University Chennai* ⊗ Naval Hydrographer's Office, Dehradun* ⊗ National Institute of Oceanography, Goa* ⊗ National Institute of Ocean Technology, Chennai ⊗ Centre for Earth Science Studies

* Agencies authorized for approval of demarcation of HTL and LTL

Information	Source
Social	
13. Socioeconomic - population, number of houses and present occupation pattern within 7 km from the periphery of the project	<ul style="list-style-type: none"> ⊗ Census Department ⊗ District Gazetteers- State Government ⊗ District Statistics- District Collectorate ⊗ International Institute of Population Sciences, Mumbai (limited data) ⊗ Central Statistical Organisation
14. Monuments and heritage sites	<ul style="list-style-type: none"> District Gazetteer Archeological Survey of India, INTACH District Collectorate Central and State Tourism Department State Tribal and Social Welfare Department
Natural Disasters	
15. Seismic data (Mining Projects)- zone no, no of earthquakes and scale, impacts on life, property existing mines	<ul style="list-style-type: none"> ⊗ Indian Meteorology Department, Pune ⊗ Geological Survey of India
16. Landslide prone zone, geomorphological conditions, degree of susceptibility to mass movement, major landslide history (frequency of occurrence/decade), area affected, population affected	<ul style="list-style-type: none"> ⊗ Space Application Centre
17. Flood/cyclone/droughts- frequency of occurrence per decade, area affected, population affected	<ul style="list-style-type: none"> ⊗ Natural Disaster Management Division in Department of Agriculture and Cooperation ⊗ Indian Meteorological Department
Industrial	
18. Industrial Estates/Clusters, Growth Centres	<ul style="list-style-type: none"> ⊗ State Industrial Corporation ⊗ Industrial Associations ⊗ State Pollution Control Boards ⊗ Confederation Indian Industries (CII) ⊗ FICCI
19. Physical and Chemical properties of raw material and chemicals (Industrial projects); fuel quality	<ul style="list-style-type: none"> ⊗ Material and Safety Data Sheets ⊗ ENVIS database of Industrial Toxicological Research Centre, Lucknow ⊗ Indian Institute Petroleum
20. Occupational Health and Industrial Hygiene-major occupational health and safety hazards, health and safety requirements, accident histories	<ul style="list-style-type: none"> ⊗ Central Labour Institute, Mumbai ⊗ Directorate of Industrial Safety ⊗ ENVIS Database of Industrial Toxicological Research Centre, Lucknow ⊗ National Institute of Occupational Health, Ahmedabad
21. Pollutant release inventories (Existing pollution sources in area within 10 km radius)	<ul style="list-style-type: none"> ⊗ Project proponents which have received EC and have commenced operations
22. Water requirement (process, cooling water, DM water, Dust suppression, drinking, green belt, fire service)	<ul style="list-style-type: none"> ⊗ EIA Reports ⊗ National and International Benchmarks

Annexure VIIIB: Summary of Available Data with Potential Data Sources for EIA

Agency	Information Available
1. Archaeological Survey of India Department of Culture Government of India Janpath, New Delhi - 110011 Asi@del3.vsnl.net.in	<ul style="list-style-type: none"> ⊙ Inventory of monuments and sites of national importance- Listing and documentation of monuments according to world heritage, pre historic, proto historic and secular, religious places and forts
2. Botanical Survey Of India P-8, Brabourne Road Calcutta 700001 Tel#033 2424922 Fax#033 2429330 Email: envis@cal2.vsnl.net.in . RO - Coimbatore, Pune, Jodhpur, Dehradun, Allahabad, Gantok, Itanagar, Port Blair	<ul style="list-style-type: none"> ⊙ Photodiversity documentation of flora at National, State and District level and flora of protected areas, hotspots, fragile ecosystems, sacred groves etc ⊙ Identification of threatened species including endemics, their mapping, population studies ⊙ Database related to medicinal plants, rare and threatened plant species ⊙ Red data book of Indian plants (Vol 1,2, and 3) ⊙ Manual for roadside and avenue plantation in India
3. Bureau of Indian Standards Manak Bhawan, 9 Bahadur Shah Zafar Marg, New Delhi 110 002 Tel#3230131, 3233375, 3239402 (10 lines) Fax : 91 11 3234062, 3239399, 3239382 Email- bis@vsnl.com	<ul style="list-style-type: none"> ⊙ Bureau of Indian Standards Committees on Earthquake Engineering and Wind Engineering have a Seismic Zoning Map and the Wind Velocity Map including cyclonic winds for the country
4. Central Water Commission (CWC) Sewa Bhawan, R.K.Puram New Delhi - 110066 cmanoff@niccwc.delhi.nic.in RO- Bangalore, Bhopal, Bhubaneshwar, Chandigarh, Coimbatore/Chennai, Delhi, Hyderabad, Lucknow, Nagpur, Patna, Shillong, Siliguri and Vadodara	<ul style="list-style-type: none"> ⊙ Central Data Bank -Collection, collation and Publishing of Hydrological, Hydrometeorological, Sediment and Water Quality data- ⊙ Basin wise Master Plans ⊙ Flood atlas for India ⊙ Flood Management and Development and Operation of Flood Forecasting System- CWC operate a network of forecasting stations Over 6000 forecasts are issued every year with about 95% of the forecasts within the permissible limit. ⊙ Water Year Books, Sediment Year Books and Water Quality Year Books. ⊙ Also actively involved in monitoring of 84 identified projects through National, State and Project level Environmental Committees for ensuring implementation of environmental safeguards
5. Central Ground Water Board (HO) N.H.IV, New CGO Complex, Faridabad - 121001 RO - Guwahati, Chandigarh, Ahemadabad, Trivandrum, Calcutta, Bhopal, Lucknow, Banglore, Nagpur, Jammu, Bhubneshwar, Raipur, Jaipur, Chennai, Hyderabad, Patna	<ul style="list-style-type: none"> ⊙ surveys, exploration, monitoring of ground water development

¹⁶ Based on web search and literature review

6.	Central Pollution Control Board Parivesh Bhawan, CBD-cum-Office Complex East Arjun Nagar, DELHI - 110 032 INDIA E-mail : cpcb@alpha.nic.in	<ul style="list-style-type: none"> ⊗ National Air Quality Monitoring Programme ⊗ National River Water Quality Monitoring Programme- Global Environment Monitoring , MINARS ⊗ Zoning Atlas Programme ⊗ Information on 17 polluting category industries (inventory, category wise distribution, compliance, implementation of pollution control programmes)
7.	Central Arid Zone Research Institute, Jodhpur Email : cazri@x400.nicgw.nic.in Regional Centre at Bhuj in Gujarat	<ul style="list-style-type: none"> ⊗ AGRIS database on all aspects of agriculture from 1975 to date ⊗ Also have cell on Agriculture Research Information System; ⊗ Working on ENVIS project on desertification ⊗ Repository of information on the state of natural resources and desertification processes and their control ⊗ The spectrum of activities involves researches on basic resource inventories; monitoring of desertification, rehabilitation and management of degraded lands and other areas
8.	Central Inland Capture Fisheries Research Institute, Barrackpore- 743101, Tel#033-5600177 Fax#033-5600388 Email : cicfri@x400.nicgw.nic.in	<ul style="list-style-type: none"> ⊗ Data Base on Ecology and fisheries of major river systems of India. Biological features of commercially important riverine and estuarine fish species. Production functions and their interactions in floodplain wetlands. ⊗ Activities - Environmental Impact Assessment for Resource Management ; Fisheries Resource surveys
9.	Central Institute of Brackish Water Aquaculture 141, Marshalls Road, Egmore , Chennai - 600 008, Tel# 044-8554866, 8554891, Director (Per) 8554851 Fax#8554851,	<ul style="list-style-type: none"> ⊗ Repository of information on brackish water fishery resources with systematic database of coastal fishery resources for ARIS ⊗ Agricultural Research Information System (ARIS) database covers State wise data on soil and water quality parameters, land use pattern, production and productivity trends, ⊗ Social, economic and environmental impacts of aquaculture farming, ⊗ Guidelines and effluent standards for aquaculture farming
10.	Central Marine Fisheries Research Institute (CMFRI), Cochin	<ul style="list-style-type: none"> ⊗ Assessing and monitoring of exploited and un-exploited fish stocks in Indian EEZ ⊗ Monitoring the health of the coastal ecosystems, particularly the endangered ecosystems in relation to artisanal fishing, mechanised fishing and marine pollution ⊗ The institute has been collecting data on the catch and effort and biological characteristics for nearly half a century based on scientifically developed sampling scheme, covering all the maritime States of the country ⊗ The voluminous data available with the institute is managed by the National Marine Living Resources Data Centre (NMLRDC)
11.	Central Water and Power Research Station, Pune Tel#020-4391801-14; 4392511; 4392825 Fax #020-4392004,4390189	<ul style="list-style-type: none"> ⊗ Numerical and Physical models for hydro-dynamic simulations
12.	Central Institute of Road Transport, Bhosari, Pune 411 026, India. Tel : +91 (20) 7125177, 7125292, 7125493, 7125494	<ul style="list-style-type: none"> ⊗ Repository of data on all aspects of performance of STUs and a host of other related road transport parameters

13. Department of Ocean Development	<ul style="list-style-type: none"> ⑨ Assessment of environment parameters and marine living resources (primary and secondary) in Indian EEZ (Nodal Agency NIO Kochi) ⑨ Stock assessment, biology and resource mapping of deep sea shrimps, lobsters and fishes in Indian EEZ (Nodal agency-Fisheries Survey of India) ⑨ Investigations of toxical algal blooms and benthic productivity in Indian EEZ (Nodal agency- Cochin University of Science and technology) ⑨ Coastal Ocean Monitoring and Prediction System (COMAP) - monitoring and modelling of marine pollution along entire Indian coast and islands. Parameters monitored are temp, salinity, DO, pH, SS, BOD, inorganic phosphate, nitrate, nitrite, ammonia, total phosphorus, total nitrite, total organic carbon, petroleum hydrocarbons, pathogenic vibrios, pathogenic E.coli, shigella, salmonella, heavy metals (Cd, Hg, Pb) and pesticide residues (DDT, BHC, Endosulfan). Monitoring is carried out along the ecologically sensitive zones and urban areas (NIO Mumbai- Apex coordinating agency). ⑨ Sea Level Measurement Programme (SELMAM)- sea level measurement at selected stations (Porbandar, Bombay, Goa, Cochin, Tuticorin, Madras, Machilipatnam, Visakhapatnam, Paradeep, Calcutta and Kavaratti (Lakshadweep Island)) along Indian coast and islands using modern tide gauges ⑨ Detailed coastal maps through Survey of India showing contour at 1/2 a metre interval in the scale of 1:25000. (Nellore- Machhalipatnam work already over) ⑨ Marine Data Centre (MDC) IMD for Ocean surface meteorology, GSI for marine geology, SOI for tide levels, Naval Hydrographic Office for bathymetry, NIO Goa for physical chemical and biological oceanography, NIO Mumbai for marine pollution, CMFRI for coastal fisheries, Institute of Ocean Management Madras for coastal geomorphology ⑨ DOD has setup Indian National Centre for Ocean Information Services (INCOIS) at Hyderabad for generation and dissemination of ocean data products (near real time data products such as sea surface temperature, potential fishing zones, upwelling zones, maps, eddies, chlorophyll, suspended sediment load etc). MDC will be integrated with INCOIS ⑨ Integrated Coastal and Marine Area Management (ICMAM) programme - GIS based information system for management of 11 critical habitats namely Pichavaram, Karwar, Gulf of Mannar, Gulf of Khambat, Gulf of Kutch, Malvan, Cochin, Coringa mangroves, Gahirmata, Sunderbans and Kadamat (Lakshadweep) ⑨ Wetland maps for Tamil Nadu and Kerala showing the locations of lagoons, backwaters, estuaries, mudflats etc (1:50000 scale) ⑨ Coral Reef Maps for Gulf of Kachch, Gulf of Mannar, Andaman and Nicobar and Lakshadweep Islands (1:50,000 scale) indicating the condition of corals, density etc
14. Environment Protection Training and Research Institute Gachibowli, Hyderabad - 500 019, India Phone: +91-40-3001241, 3001242, 3000489 Fax: +91-40- 3000361 E-mail: info@eptri.com	<ul style="list-style-type: none"> ⑨ Environment Information Centre- has appointed EPTRI as the Distributed Information Centre for the Eastern Ghats region of India. EIC Collaborates with the Stockholm Environment Institute Sweden Database on Economics of Industrial Pollution Prevention in India Database of Large and Medium Scale Industries of Andhra Pradesh Environmental Status of the Hyderabad Urban Agglomeration Study on 'water pollution-health linkages' for a few Districts of A.P

		<ul style="list-style-type: none"> ⑨ Environment Quality Mapping <ul style="list-style-type: none"> Macro level studies for six districts in the State of Andhra Pradesh Micro level studies for two study zones presenting the permissible pollutant load and scoping for new industrial categories Zonation of the IDA, Parwada which helped APIIC to promote the land for industrial development Disaster management plan for Visakhapatnam Industrial Bowl Area
15.	<p>Forest Survey of India (FSI) Kaulagarh Road, P.O., IPE Dehradun - 248 195 Tel# 0135-756139, 755037, 754507 Fax # 91-135-759104 E-Mail : fsidir@nde.vsnl.net.in fsihq@nde.vsnl.net.in</p> <p>RO- Banglore, Calcutta, Nagpur and Shimla</p>	<ul style="list-style-type: none"> ⑨ State of Forest Report (Biannual) ⑨ National Forest Vegetation Map (Biannual exercise) (on 1: 1 million scale) ⑨ Thematic mapping on 1:50,000 scale depicting the forest type, species composition, crown density of forest cover and other landuse National ⑨ Basic Forest Inventory System ⑨ Inventory survey of non forest area ⑨ Forest inventory report providing details of area estimates, topographic description, health of forest, ownership pattern, estimation of volume and other growth parameters such as height and diameter in different types of forest, estimation of growth, regeneration and mortality of important species, volume equation and wood consumption of the area studied
16.	<p>Geological Survey of India 27 Jawaharlal Nehru Road, Calcutta 700 016, India Telephone +91-33- 2496941 FAX 91-33-2496956 gsi_chq@vsnl.com</p>	<ul style="list-style-type: none"> ⑨ Environmental hazards zonation mapping in mineral sector ⑨ Codification of base line information of geo-environmental appreciation of any terrain and related EIA and EMP studies ⑨ Lineament and geomorphological map of India on 1:20,000 scale. ⑨ Photo-interpreted geological and structural maps of terrains with limited field checks.
17.	<p>Indian Council of Agriculture Research, Krishi Bhawan, New Delhi, Tel#011-338206</p> <ul style="list-style-type: none"> - ICAR complex, Goa- Agro metrology - Central Arid Zone Research Institute- Agro forestry - Central Soil salinity Research Institute, - Indian Institute of Soil Science - Central Soil and Water Conservation Research and Training Institute - National Bureau of Soil Survey and Landuse Planning 	<ul style="list-style-type: none"> ⑨ A total of 80,000 profiles at 10 kms grid across the country were analyzed to characterize the soils of India. ⑨ Detailed soil maps of the Country (1:7 million), State (1:250,000) and districts map (1:50,000) depicting extent of degradation (1:4.4 millions) have been prepared. ⑨ Thematic maps depicting soil depth, texture drainage, calcareousness, salinity, pH, slope and erosion have been published ⑨ Agro-climate characterization of the country based on moisture, thermal and sunshine regimes ⑨ Agro-ecological zones (20) and sub-zones (60) for the country were delineated based on physiography, soils, climate, Length of Growing Period and Available Water Content, and mapped on 1:4.4 million scale. ⑨ Digitization of physiography and soil resource base on 1:50,000 scale for 14 States have been completed. ⑨ .Soil fertility maps of N,P,K,S and Zn have also been developed ⑨ Water quality guidelines for irrigation and naturally occurring saline/sodic water ⑨ Calibration and verification of ground water models for predicting water logging and salinity hazards in irrigation commands
18.	<p>Indian Bureau of Mines Indira Bhawan, Civil Lines Nagpur Ph no - 0712-533 631, Fax- 0712-533 041</p>	<ul style="list-style-type: none"> ⑨ National mineral inventory for 61 minerals and mineral maps ⑨ Studies on environmental protection and pollution control in regard to the mining and mineral beneficiation operations ⑨ Collection, processing and storage of data on mines, minerals and mineral-based industries, collection and maintenance of world mineral intelligence, foreign mineral legislation and other related matters

19.	Indian Meteorology Department Shivaji nagar, Pune 41100 RO- Mumbai, Chennai, Calcutta, New Delhi, Nagpur, Guwahati	<ul style="list-style-type: none"> ⊙ Meteorological data ⊙ Background air quality monitoring network under Global Atmospheric Watch Programme (operates 10 stations) ⊙ Seismicity map, seismic zoning map; seismic occurrences and cyclone hazard monitoring; list of major earthquakes ⊙ Climatological Atlas of India , Rainfall Atlas of India and Agroclimatic Atlas of India ⊙ Monthly bulletin of Climate Diagnostic Bulletin of India ⊙ Environmental Meteorological Unit of IMD at Delhi to provide specific services to MoEF
20.	INTACH Natural Heritage, 71 Lodi Estate, New Delhi-110 003 Tel. 91-11-4645482, 4632267/9, 4631818, 4692774, 4641304 Fax : 91- 11-4611290 E-mail : nh@intach.net	<ul style="list-style-type: none"> ⊙ Listing and documentation of heritage sites identified by municipalities and local bodies (Listing excludes sites and buildings under the purview of the Archaeological Survey of India and the State Departments of Archaeology)
21.	Industrial Toxicology Research Centre Post Box No. 80, Mahatma Gandhi Marg, Lucknow-226001, Phone: +91-522- 221856,213618,228227; Fax : +91- 522 228227 Email: itrc@itrcindia.org	<ul style="list-style-type: none"> ⊙ Activities include health survey on occupational diseases in industrial workers, air and water quality monitoring studies, ecotoxicological impact assessment, toxicity of chemicals, human health risk assessment ⊙ Five databases on CD-ROM in the area of environmental toxicology viz: TOXLINE, CHEMBANK, POISINDEX, POLTOX and PESTBANK. The Toxicology Information Centre provides information on toxic chemicals including household chemicals ⊙ ENVIS centre and created a full-fledged computerized database (DABTOC) on toxicity profiles of about 450 chemicals
22.	Indian Institute of Forest Management Post Box No. 357, Nehru Nagar Bhopal - 462 003 Phone # 0755-575716, 573799, 765125, 767851 Fax # 0755-572878	<ul style="list-style-type: none"> ⊙ Consultancy and research on joint forest management (Ford Foundation, SIDA, GTZ, FAO etc)
23.	Indian Institute of Petroleum Mohkampur , Dehradun, India, 248005 0135- 660113 to 116 0135- 671986	<ul style="list-style-type: none"> ⊙ Fuel quality characterisation ⊙ Emission factors
24.	Ministry of Environment and Forest	<ul style="list-style-type: none"> ⊙ Survey of natural resources ⊙ National river conservation directorate ⊙ Environmental research programme for eastern and western ghats ⊙ National natural resource management system ⊙ Wetlands conservation programme- survey, demarcation, mapping landscape planning, hydrology for 20 identified wetlands National wasteland identification programme
25.	Mumbai Metropolitan Regional Development Authority	<ul style="list-style-type: none"> ⊙ Mumbai Urban Transport Project ⊙ Mumbai Urban Development Project ⊙ Mumbai Urban Rehabilitation Project ⊙ Information on MMR; statistics on councils and corporations Regional Information Centre- Basic data on population, employment, industries and other sectors are regularly collected and processed

26.	Municipal Corporation of Greater Mumbai	<ul style="list-style-type: none"> ⊙ Air Quality Data for Mumbai Municipal Area ⊙ Water quality of lakes used for water supply to Mumbai
27.	Ministry of Urban Development Disaster Mitigation and Vulnerability Atlas of India Building Materials & Technology Promotion Council G-Wing, Nirman Bhavan, New Delhi-110011 Tel: 91-11-3019367 Fax: 91-11-3010145 E-Mail: bmtpc@del2.vsnl.net.in	<ul style="list-style-type: none"> ⊙ Identification of hazard prone area ⊙ Vulnerability Atlas showing areas vulnerable to natural disasters ⊙ Land-use zoning and design guidelines for improving hazard resistant construction of buildings and housing ⊙ State wise hazard maps (on cyclone, floods and earthquakes)
28.	Natural Disaster Management Division in Department of Agriculture and Cooperation	<ul style="list-style-type: none"> ⊙ Weekly situation reports on recent disasters, reports on droughts, floods, cyclones and earthquakes
29.	National Bureau Of Soil Survey & Land Use Planning P.O. Box No. 426, Shankar Nagar P.O., Nagpur-440010 Tel#91-712-534664,532438,534545 Fax#:91-712-522534 RO- Nagpur, New Delhi, Bangalore, Calcutta, Jorhat, Udaipur	<ul style="list-style-type: none"> ⊙ NBSS&LUP Library has been identified as sub centre of ARIC (ICAR) for input to AGRIS covering soil science literature generated in India ⊙ Research in weathering and soil formation, soil morphology, soil mineralogy, physicochemical characterisation, pedogenesis, and landscape-climate-soil relationship. ⊙ Soil Series of India- The soils are classified as per Soil Taxonomy. The described soil series now belong to 17 States of the country. ⊙ Landuse planning- watershed management, land evaluation criteria, crop efficiency zoning ⊙ Soil Information system is developed state-wise at 1:250,000 scale. Presently the soil maps of all the States are digitized, processed and designed for final output both digital and hardcopy. The thematic layers and interpreted layers of land evaluation (land capability, land irrigability and crop suitability), Agro-Ecological Zones and soil degradation themes are prepared. ⊙ Districts level information system is developed for about 15 districts at 1: 50, 000 scale. The soil information will be at soil series level in this system. Soil resource inventory of States, districts water-sheds (1:250,000; 1:50,000; 1:10,000/8000)
30.	National Institute of Ocean Technology, Velacherry-Tambaram main road Narayanapuram Chennai, Tamil Nadu Tel#91-44-2460063 / 2460064/ 2460066/ 2460067 Fax#91-44-2460645	<ul style="list-style-type: none"> ⊙ Waste load allocation in selected estuaries (Tapi estuary and Ennore creek) is one the components under the Integrated Coastal and Marine Area Management (ICMAM) programme of the Department of Ocean Development ICMAM is conducted with an IDA based credit to the Government of India under the Environmental Capacity Building project of MoEF (waste assimilation capacity of Ennore creek is over) ⊙ Physical oceanographic component of Coastal & Ocean monitoring Predictive System (COMAPS) a long term monitoring program under the Department of Ocean Development ⊙ Identification of suitable locations for disposal of dredge spoil using mathematical models & environmental criteria ⊙ EIA Manual and EIA guidelines for port and harbour projects
31.	National Institute of Oceanography, Goa RO- Mumbai, Kochi	<ul style="list-style-type: none"> ⊙ Coastal Ocean Monitoring and Predictions(COMAP)-Monitoring of coastal waters for physicochemical and biological parameters including petroleum hydrocarbons, trace metals, heavy metals, and biomass of primary (phytoplankton) and secondary (zooplankton, microbial and benthic organisms) ⊙ Marine Biodiversity of selected ecosystem along the West Coast of India

32.	National Botanical Research Institute, Post Box No 436 Rana Pratap Marg Lucknow- 226001, Tel: (+91) 522 271031-35 Fax: (+91) 522 282849, 282881 Lucknow	<ul style="list-style-type: none"> ⊗ Dust filtering potential of common avenue trees and roadside shrubs has been determined, besides studies have also been conducted on heavy-metals accumulation potential of aquatic plants supposedly useful as indicators of heavy metal pollution in water bodies and capable of reducing the toxic metals from water bodies. ⊗ Assessment of bio-diversity of various regions of India
33.	National Geophysical Research Institute, Uppal Road, Hyderabad Telephone:0091-40-7171124, FAX:0091-40-7171564	<ul style="list-style-type: none"> ⊗ Exploration, assessment and management of ground water resources including ground water modelling and pollution studies
34.	National Environmental Engineering Research Institute, Nagpur RO- Mumbai, Delhi, Chennai, Calcutta, Ahmedabad, Cochin, Hyderabad, Kanpur	<ul style="list-style-type: none"> ⊗ National Air Quality Monitoring (NAQM) for CPCB ⊗ Database on cleaner technologies of industrial productions
35.	National Hydrology Institute, Roorkee RO- Belgaum (Hard Rock Regional Centre), Jammu (Western Himalayan Regional Centre), Guwahati (North Eastern Regional Centre), Kakinada (Deltaic Regional Centre), Patna (Ganga Plains North Regional Centre), and Sagar (Ganga Plains South)	<ul style="list-style-type: none"> ⊗ Basin studies, hydrometeorological network improvement, hydrological year book, hydrological modelling, regional flood formulae, reservoir sedimentation studies, environmental hydrology, watershed development studies, tank studies, and drought studies.
36.	National Institute Of Urban Affairs, India Habitat Centre, New Delhi	<ul style="list-style-type: none"> ⊗ Urban Statistics Handbook
37.	National Institute of Occupational Health Meghaninagar, Ahmedabad RO- Banglore, Calcutta	<ul style="list-style-type: none"> ⊗ epidemiological studies and surveillance of hazardous occupations including air pollution, noise pollution, agricultural hazards, industrial hazards in organised sectors as well as small scale industries, carcinogenesis, pesticide toxicology, etc ⊗ WHO collaborative centre for occupational health for South East Asia region and the lead institute for the international programme on chemical safety under IPCS (WHO)
38.	NRSA Data Centre Department of Space, Balanagar, Hyderabad 500 037 Ph- 040-3078560 3078664 sales@nrsa.gov.in	<ul style="list-style-type: none"> ⊗ Satellite data products (raw data, partially processed (radiometrically corrected but geometrically uncorrected), standard data (radiometrically and geometrically corrected), geocoded data(1:50,000 and 1:25000 scale), special data products like mosaiced, merged and extracted) available on photographic (B&W and FCC in form of film of 240 mm X 240mm or enlargements/paper prints in scale varying between 1:1M and 1:12500 and size varying between 240mm and 1000mm) and digital media (CD-ROMs, 8 mm tapes)
39.	Rajiv Gandhi National Drinking Water Mission	<ul style="list-style-type: none"> ⊗ Database for groundwater using remote sensing technology (Regional Remote Sensing Service Centre involved in generation of ground water prospect maps at 1:50,000 scale for the State of Kerala, Karnataka, AP, MP and Rajasthan for RGNDWM)
40.	Space Application Centre Value Added Services Cell (VASC) Remote Sensing Application Area Ahmedabad 380 053 079-676 1188	<ul style="list-style-type: none"> ⊗ National Natural Resource Information System ⊗ Landuse mapping for coastal regulation zone (construction setback line) upto 1:12500 scale ⊗ Inventory of coastal wetlands, coral reefs, mangroves, seaweeds ⊗ Monitoring and condition assessment of protected coastal areas

	Fax- 079-6762735	<ul style="list-style-type: none"> ⊙ Wetland mapping and inventory ⊙ Mapping of potential hotspots and zoning of environmental hazards ⊙ General geological and geomorphological mapping in diverse terrain ⊙ Landslide risk zonation for Tehre area
41.	State Pollution Control Board	<ul style="list-style-type: none"> ⊙ State Air Quality Monitoring Programme ⊙ Inventory of polluting industries ⊙ Identification and authorization of hazardous waste generating industries ⊙ Inventory of biomedical waste generating industries ⊙ Water quality monitoring of water bodies receiving wastewater discharges ⊙ Inventory of air polluting industries ⊙ Industrial air pollution monitoring ⊙ Air consent, water consent, authorization, environment monitoring reports
42.	State Ground Water Board	
43.	Survey of India	<ul style="list-style-type: none"> ⊙ Topographical surveys on 1:250,000 scales, 1:50,000 and 1:25,000 scales ⊙ Digital Cartographical Data Base of topographical maps on scales 1:250,000 and 1:50,000 ⊙ Data generation and its processing for redefinition of Indian Geodetic Datum ⊙ Maintenance of National Tidal Data Centre and receiving/ processing of tidal data of various ports. ⊙ Coastal mapping along the Eastern coast line has been in progress to study the effect of submergence due to rise in sea-level and other natural phenomenon. Ground surveys have been completed for the proposed coastal region and maps are under printing. ⊙ District planning maps containing thematic information (135 maps) have been printed out of 249 maps covering half the districts of India. Districts planning maps for remaining half of the area are being processed by National Atlas and Thematic Mapping Organisation (NATMO)
44.	Town and Country Planning Organisation	<ul style="list-style-type: none"> ⊙ Urban mapping - Thematic maps and graphic database on towns (under progress in association with NRSA and State town planning department)
45.	Wildlife Institute of India Post Bag No. 18, Chandrabani Dehradun - 248 001, Uttaranchal Tel#0135 640111 -15, Fax#0135 640117 email : wii@wii .	<ul style="list-style-type: none"> ⊙ Provide information and advice on specific wildlife management problems. ⊙ National Wildlife Database
46.	Zoological Survey of India Prani Vigyan Bhawan 'M' Block, New Alipore Calcutta - 700 053 Phone # 91-33-4786893, 4783383 Fax # 91-33-786893 RO - Shillong, Pune, Dehradun, Jabalpur, Jodhpur, Chennai, Patna, Hyderabad, Canning, Behrampur, Kozikode, Itanagar, Digha, Port Blair, Solan	<ul style="list-style-type: none"> ⊙ Red Book for listing of endemic species ⊙ Survey of faunal resources

ANNEXURE IX
Impact Prediction Tools

Table 1: Choice of Models for Impact Prediction: Air Environment*

Model	Application	Remarks
ISCST 3	<ul style="list-style-type: none"> ▪ Appropriate for point, area and line sources ▪ Application for flat or rolling terrain ▪ Transport distance up to 50 km valid ▪ Computes for 1 hr to annual averaging periods 	<ul style="list-style-type: none"> ▪ Can take up to 99 sources ▪ Computes concentration on 600 receptors in Cartesian on polar coordinate system ▪ Can take receptor elevation ▪ Requires source data, meteorological and receptor data as input.
AERMOD with AERMET	<ul style="list-style-type: none"> ▪ Settling and dry deposition of particles; ▪ Building wake effects (excluding cavity region impacts); ▪ Point, area, line, and volume sources; ▪ Plume rise as a function of downwind distance; ▪ Multiple point, area, line, or volume sources; ▪ Limited terrain adjustment; ▪ Long-term and short-term averaging modes; ▪ Rural or urban modes; ▪ Variable receptor grid density; ▪ Actual hourly meteorology data 	<ul style="list-style-type: none"> ▪ Can take up to 99 sources ▪ Computes concentration on 600 receptors in Cartesian on polar coordinate system ▪ Can take receptor elevation ▪ Requires source data, meteorological and receptor data as input.
PTMAX	<ul style="list-style-type: none"> ▪ Screening model applicable for a single point source ▪ Computes maximum concentration and distance of maximum concentration occurrence as a function of wind speed and stability class 	<ul style="list-style-type: none"> ▪ Require source characteristics ▪ No met data required ▪ Used mainly for ambient air monitoring network design
PTDIS	<ul style="list-style-type: none"> ▪ Screening model applicable for a single point source ▪ Computes maximum pollutant concentration and its occurrences for the prevailing meteorological conditions 	<ul style="list-style-type: none"> ▪ Require source characteristics ▪ Average met data (wind speed, temperature, stability class <i>etc.</i>) required ▪ Used mainly to see likely impact of a single source
MPTER	<ul style="list-style-type: none"> ▪ Appropriate for point, area and line sources applicable for flat or rolling terrain ▪ Transport distance up to 50 km valid ▪ Computes for 1 hr to annual averaging periods ▪ Terrain adjustment is possible 	<ul style="list-style-type: none"> ▪ Can take 250 sources ▪ Computes concentration at 180 receptors up to 10 km ▪ Requires source data, meteorological data and receptor coordinates
CTDM PLUS (Complex Terrain Dispersion Model)	<ul style="list-style-type: none"> ▪ Point source steady state model, can estimate hrly average concentration in isolated hills/ array of hills 	<ul style="list-style-type: none"> ▪ Can take maximum 40 Stacks and computes concentration at maximum 400 receptors ▪ Does not simulate calm met conditions ▪ Hill slopes are assumed not to exceed 15 degrees ▪ Requires sources, met and terrain characteristics and receptor details

Model	Application	Remarks
UAM (Urban Airshed Model)	<ul style="list-style-type: none"> ▪ 3-D grid type numerical simulation model ▪ Computes O₃ concentration short term episodic conditions lasting for 1 or 2 days resulting from NO_x and VOCs ▪ Appropriate for single urban area having significant O₃ problems 	<ul style="list-style-type: none"> ▪
RAM (Rural Airshed Model)	<ul style="list-style-type: none"> ▪ Steady state Gaussian plume model for computing concentration of relatively stable pollutants for 1 hr to 1 day averaging time ▪ Application for point and area sources in rural and urban setting 	<ul style="list-style-type: none"> ▪ Suitable for flat terrains ▪ Transport distance less than 50 km.
CRESTER	<ul style="list-style-type: none"> ▪ Applicable for single point source either in rural or urban setting ▪ Computes highest and second highest concentration for 1hr, 3hr, 24hr and annual averaging times ▪ Tabulates 50 highest concentration for entire year for each averaging times 	<ul style="list-style-type: none"> ▪ Can take up to 19 Stacks simultaneously at a common site. ▪ Unsuitable for cool and high velocity emissions ▪ Do not account for tall buildings or topographic features ▪ Computes concentration at 180 receptor, circular wing at five downwind ring distance 36 radials ▪ Require sources, and met data
OCD (Offshore and coastal Dispersion Model)	<ul style="list-style-type: none"> ▪ It determines the impact of offshore emissions from point sources on the air quality of coastal regions ▪ It incorporates overwater plume transport and dispersion as well as changes that occur as the plume crosses the shore line ▪ Most suitable for overwater sources shore onshore receptors are below the lowest shore height 	<ul style="list-style-type: none"> ▪ Requires source emission data ▪ Require hrly met data at offshore and onshore locations like water surface temperature; overwater air temperature; relative humidity <i>etc.</i>
FDM (Fugitive Dust Model)	<ul style="list-style-type: none"> ▪ Suitable for emissions from fugitive dust sources ▪ Source may be point, area or line (up to 121 source) ▪ Require particle size classification max. up to 20 sizes ▪ Computes concentrations for 1 hr, 3hr, 8hr, 24hr or annual average periods 	<ul style="list-style-type: none"> ▪ Require dust source particle sizes ▪ Source coordinates for area sources, source height and geographic details ▪ Can compute concentration at max. 1200 receptors ▪ Require met data (wind direction, speed, Temperature, mixing height and stability class) ▪ Model do not include buoyant point sources, hence no plume rise algorithm
RTDM (Rough Terrain Diffusion Model)	<ul style="list-style-type: none"> ▪ Estimates GLC is complex/rough (or flat) terrain in the vicinity of one or more co-located point sources ▪ Transport distance max. up to 15 km to up to 50 km ▪ Computes for 1 to 24 hr. or annual average concentrations 	<ul style="list-style-type: none"> ▪ Can take up to 35 co-located point sources ▪ Require source data and hourly met data ▪ Computes concentration at maximum 400 receptors ▪ Suitable only for non reactive gases ▪ Do not include gravitational effects or depletion mechanism such as rain/

Model	Application	Remarks
		wash out, dry deposition
CDM(Climatologically Dispersion Model)	<ul style="list-style-type: none"> It is a climatologically steady state GPM for determining long term (seasonal or annual) Arithmetic average pollutant concentration at any ground level receptor in an urban area 	<ul style="list-style-type: none"> Suitable for point and area sources in urban region, flat terrain Valid for transport distance less than 50 km Long term averages: One month to one year or longer
PLUVUE-II (Plume Visibility Model)	<ul style="list-style-type: none"> Applicable to assess visibility impairment due to pollutants emitted from well defined point sources It is used to calculate visual range reduction and atmospheric discoloration caused by plumes It predicts transport, atmospheric diffusion, chemical, conversion, optical effects, and surface deposition of point source emissions. 	<ul style="list-style-type: none"> Require source characteristics, met data and receptor coordinates & elevation Require atmospheric aerosols (background & emitted) characteristics, like density, particle size Require background pollutant concentration of SO₄, NO₃, NO_x, NO₂, O₃, SO₂ and deposition velocities of SO₂, NO₂ and aerosols
MESO-PUFF II (Meso scale Puff Model)	<ul style="list-style-type: none"> It is a Gaussian, Variable trajectory, puff superposition model designed to account for spatial and temporal variations in transport, diffusion, chemical transformation and removal mechanism encountered on regional scale. Plume is modeled as a series of discrete puffs and each puff is transported independently Appropriate for point and area sources in urban areas Regional scale model. 	<ul style="list-style-type: none"> Can model five pollutants simultaneously (SO₂, SO₄, NO_x, HNO₃ and NO₃) Require source characteristics Can take 20 point sources or 5 area source For area source – location, effective height, initial puff size, emission is required Computes pollutant concentration at max. 180 discrete receptors and 1600 (40 x 40) grided receptors Require hourly surface data including cloud cover and twice a day upper air data (pressure, temp, height, wind speed, direction) Do not include gravitational effects or depletion mechanism such as rain/wash out, dry deposition

Table 2: Choice of Models for Impact Modeling: Noise Environment*

Model	Application
FHWA (Federal Highway Administration)	Noise Impact due to vehicular movement on highways
Dhwani	For predictions of impact due to group of noise sources in the industrial complex (multiple sound sources)
Hemispherical sound wave propagation Air Port	Fore predictive impact due to single noise source For predictive impact of traffic on airport and rail road

Table 3: Choice of Models for Impact Modeling: Land Environment*

Model	Application	Remarks
Digital Analysis Techniques	Provides land use / land cover distribution	
Ranking analysis for soil suitability criteria	Provides suitability criteria for developmental conversation activities	Various parameters viz. depth, texture, slope, erosion status, geomorphology, flooding hazards, GW potential, land use <i>etc.</i> , are used.

Table 4: Choice of Models for Impact Modeling: Water Environment

Model	Application	Remarks
QUAL-II E	Wind effect is insignificant, vertical dispersive effects insignificant applicable to streams Data required Deoxygenation coefficients, re-aeration coefficients for carbonaceous, nitrogenous and benthic substances, dissolved oxygen deficit	Steady state or dynamic model
	The model is found excellent to generate water quality parameters Photosynthetic and respiration rate of suspended and attached algae	
	Parameters measured up to 15 component can be simulated in any combination, e.g. ammonia, nitrite, nitrate, phosphorous, carbonaceous BOD, benthic oxygen demand, DO, coliforms, conservative substances and temperature	
DOSAG-3, USEPA: (1-D) RECEIV – II, USEPA	Water quality simulation model for streams & canal A general Water quality model	Steady-state
Explore –I, USEPA	A river basin water quality model	Dynamic, Simple hydrodynamics
HSPE, USEPA	Hydrologic simulation model	Dynamic, Simple hydrodynamics
RECEIVE-II, USEPA	A general dynamic planning model for water quality management	
Stanford watershed model	This model simulates stream flows once historic precipitation data are supplied The major components of the hydrologic cycle are modeled including interception, surface detention, overland inflow, groundwater, evapo-transpiration and routing of channel flows, temperature, TDS, DO, carbonaceous BOD coliforms, algae, zooplanktons, nitrite, nitrate, ammonia, phosphate and conservative	

Model	Application	Remarks
	substances can be simulated	
Hydrocomp model	Long-term meteorological and wastewater characterization data is used to simulate stream flows and stream water quality	Time dependant (Dynamic)
Stormwater Management model (SWMM)	Runoff is modeled from overland flow, through surface channels, and through sewer network Both combined and separate sewers can be modeled. This model also enables to simulate water quality effects to stormwater or combined sewer discharges. This model simulates runoff resulting from individual rainfall events.	Time Dependent
Battelle Reservoir model	Water body is divided into segments along the direction of the flow and each segment is divided into number of horizontal layers. The model is found to generate excellent simulation of temperature and good prediction of water quality parameters. The model simulates temperature, DO, total and benthic BOD, phytoplankton, zooplankton, organic and inorganic nitrogen, phosphorous, coliform bacteria, toxic substances and hydrodynamic conditions.	Two Dimensional multi-segment model
TIDEP (Turbulent diffusion temperature model reservoirs)	Horizontal temperature homogeneity Coefficient of vertical turbulent diffusion constant for charge of area with depth negligible coefficient of thermal exchange constant Data required wind speed, air temperature, air humidity, net incoming radiation, surface water temperature, heat exchange coefficients and vertical turbulent diffusion coefficients.	Steady state model
BIOLAKE	Model estimates potential fish harvest from a take	Steady state model
Estuary models/ estuarial Dynamic model	It is simulates tides, currents, and discharge in shallow, vertically mixed estuaries excited by ocean tides, hydrologic influx, and wind action Tides, currents in estuary are simulated	Dynamic model
Dynamic Water Quality Model	It simulates the mass transport of either conservative or non-conservative quality constituents utilizing information derived from the hydrodynamic model Bay-Delta model is the programme generally used. Up to 10 independent quality parameters of either conservative or non-conservative type plus the BOD-DO coupled relationship can be handled	Dynamic model
HEC -2	To compute water surface profiles for stead7y, gradually: varying flow in both prismatic & non-prismatic channels	
SMS	Lake circulation, salt water intrusion, surface water profile simulation model	Surface water Modeling system Hydrodynamic model
RMA2	To compute flow velocities and water surface	Hydrodynamic analysis

Model	Application	Remarks
	elevations	model
RMA4	Solves advective-diffusion equations to model up to six non-interacting constituents	Constituent transport model
SED2D-WES	Model simulates transport of sediment	Sediment transport model
HIVEL2D	Model supports subcritical and supercritical flow analysis	A 2-dimensional hydrodynamic model
MIKE-II, DHI	Model supports, simulations of flows, water quality, and sediment transport in estuaries, rives, irrigation systems, channels & other water bodies	Professional Engineering software package

Table 5: Choice of Models for Impact Modeling: Biological Environment*

Name	Relevance	Applications	Remarks
Flora			
Sample plot methods	Density and relative density	Average number of individuals species per unit area	The quadrant sampling technique is applicable in all types of plant communities and for the study of submerged, sessile (attached at the base) or sedentary plants
	Density and relative dominance	Relative degree to which a species predominates a community by its sheer numbers, size bulk or biomass	
	Frequency and relative frequency importance value	Plant dispersion over an area or within a community	Commonly accepted plot size: 0.1 m ² - mosses, lichens & other mat-like plants
		Average of relative density, relative dominance and relative frequency	0.1 m ² - herbaceous vegetation including grasses
			10.20 m ² – for shrubs and saplings up to 3m tall, and
			100 m ² – for tree communities
Transects & line intercepts methods	Cover	Ratio of total amount of line intercepted by each species and total length of the line intercept given its cover	This methods allows for rapid assessment of vegetation transition zones, and requires minimum time or equipment of establish
	Relative dominance	It is the ratio of total individuals of a species and total individuals of all species	Two or more vegetation strata can be sampled simultaneously
Plot-less sampling methods	Mean point plant	Mean point – plant distance	Vegetation measurements are determined from points rather than being determined in an
	Mean area per plant	Mean area per plant	

Name	Relevance	Applications	Remarks
			area with boundaries
	Density and relative density		Method is used in grass-land and open shrub and tree communities
	Dominance and relative dominance		It allows more rapid and extensive sampling than the plot method
	Importance value		Point- quarter method is commonly used in woods and forests.
Fauna			
Species list methods	Animal species list	List of animal communities observed directly	Animal species lists present common and scientific names of the species involved so that the faunal resources of the area are catalogued
Direct Contact Methods	Animal species list	List of animals communities observed directly	This method involves collection, study and release of animals
Count indices methods (Roadside and aerial count methods)	Drive counts Temporal counts	Observation of animals by driving them past trained observers	Count indices provide estimates of animal populations and are obtained from signs, calls or trailside counts or roadside counts
	Call counts	Count of all animals passing a fixed point during some stated interval of time	These estimates, through they do not provide absolute population numbers, Provide an index of the various species in an area
			Such indices allow comparisons through the seasons or between sites or habitats
Removal methods	Population size	Number of species captured	Removal methods are used to obtain population estimates of small mammals, such as, rodents through baited snap traps
Market capture methods	Population size estimate (M)	Number of species originally marked (T) Number of marked animals recaptured (t) and total number of animals captured during census (n) $N = nT/t$	It involves capturing a portion of the population and at some later date sampling the ratio of marked to total animals caught in the population

Table 6: Choice of Models for Impact Predictions: Socio-economic Environment*

Relevance		
Name	Application	Remarks
Extrapolative Methods	A prediction is made that is consistent with past and present socio-economic data, e.g. a prediction based on the linear extrapolation of current trends	
Intuitive Forecasting (Delphi techniques)	Delphi technique is used to determine environmental priorities and also to make intuitive predictions through the process of achieving group consensus	Conjecture Brainstorming Heuristic programming Delphi consensus
Trend extrapolation and correlation	Predictions may be obtained by extrapolating present trends Not an accurate method of making socio-economic forecasts, because a time series cannot be interpreted or extrapolated very far into the future with out some knowledge of the underlying physical, biological, and social factors	Trend breakthrough precursor events correlation and regression
Metaphors and analogies	The experience gained else where is used to predict the socio-economic impacts	Growth historical simulation commonsense forecasts
Scenarios	Scenarios are common-sense forecasts of data. Each scenario is logically constructed on model of a potential future for which the degrees of “confidence” as to progression and outcome remain undefined	Common-sense
Dynamic modeling (Input- Out model)	Model predicts net economic gain to the society after considering all inputs required for conversion of raw materials along with cost of finished product	
Normative Methods	Desired socio-economic goals are specified and an attempt is made to project the social environment backward in time to the present to examine whether existing or planned resources and environmental programmes are adequate to meet the goals	Morphological analysis technology scanning contextual mapping - functional array - graphic method Mission networks and functional arrays decision trees & relevance trees matrix methods scenarios

* **NOTE:** (i) If a project proponent prefer to use any model other than listed, can do so, with prior concurrence of concerned appraisal committee. (ii) Project-specific proposed prediction tools need to be identified by the project proponent and shall be incorporated in the draft ToR to be submitted to the Authority for the consideration and approval by the concerned EAC/SEAC.

ANNEXURE X

**Form through which the State Governments/Administration of
the Union Territories Submit Nominations for SEIAA and SEAC
for the Consideration and Notification by the
Central Government**

Form for Nomination of a professional/expert as Chairperson / Member / Secretary of the SEIAA / EAC / SEAC						
1 Name (in block letters)						
2 Address for communication						
3 Age & Date of Birth (Shall be less than 67 years for the members and 72 years for the Chairman)						
4 Area of Expertise (As per Appendix VI)						
5	Professional Qualifications (As per Appendix VI)	Qualification(s)	University	Year of passing	Percentage of marks	
6	Work experience (High light relevant experience as per Appendix VI)	Position	Years of association		Nature of work. If required, attach separate sheets	
			From	to		Period in years
7	Present position and nature of job	Serving Central / State Government Office?			Yes/No	
		Engaged in industry or their associations?			Yes/No	
		Associated with environmental activism?			Yes/No	
		If no is the answer for above three, please specify the present position and name of the organization				
8	Whether experienced in the process of prior environmental clearance?	Yes/No. If yes, please specify the experience in a separate sheet (Please restrict to 500 words)				
9	Whether any out-standing expertise has been acquired?	Yes/ No If yes, please provide details in a separate sheet (Please restrict to 500 words).				
10	Any other relevant information?	May like to attach separate sheets (Research projects, consultancy projects, publications, memberships in associations, trainings undergone, international exposure cum experience etc.)				

The Government of.....is pleased to forward the Nomination of Dr./Sh. for the position of Chairperson / Member / Secretary of the SEIAA / SEAC / EAC to the Ministry of Environment & Forests, the Government of India for the Notification.

(Authorized Signature with Seal)

ANNEXURE XI
Composition of EAC/SEAC

Composition of the EAC/SEAC

The Members of the EAC shall be Experts with the requisite expertise and experience in the following fields /disciplines. In the event that persons fulfilling the criteria of “Experts” are not available, Professionals in the same field with sufficient experience may be considered:

- Environment Quality Experts: Experts in measurement/monitoring, analysis and interpretation of data in relation to environmental quality
- Sectoral Experts in Project Management: Experts in Project Management or Management of Process/Operations/Facilities in the relevant sectors.
- Environmental Impact Assessment Process Experts: Experts in conducting and carrying out Environmental Impact Assessments (EIAs) and preparation of Environmental Management Plans (EMPs) and other Management plans and who have wide expertise and knowledge of predictive techniques and tools used in the EIA process
- Risk Assessment Experts
- Life Science Experts in floral and faunal management
- Forestry and Wildlife Experts
- Environmental Economics Expert with experience in project appraisal

ANNEXURE XII

Best Practices & Latest Technologies available and reference

Technological Aspects

Cleaner technologies

Steel melting in EAF or induction furnace uses large quantities of raw materials, energy and water. As with any industry, these need to be managed well in order to maximize productivity and profits. As such, improving energy and resource efficiency should be approached from several directions. A strong corporate-wide energy and resource management program is essential. While process technologies described in Section 3.2 present well-documented opportunities for improvement, equally important is fine-tuning the production process, sometimes producing even greater savings. In section 3.3.1, are some measures concerning these and other general crosscutting utilities that apply to this industry.

DC arc furnace with water cooled furnace wall

Large energy saving is achieved in an EAF, which melts and refines ferrous materials such as steel scrap, by changing its power source from conventional three-phase AC to DC using a central electrode at top and bottom. The principle and mechanism are:

- it can melt materials uniformly
- the metal is melted and agitated by the electric current flowing through it and the magnetic field

- by adopting water cooled furnace wall, high efficiency operation is achievable

Energy Saving

- Specific power consumption is reduced by 5 to 10%
- Furnace maintenance materials are reduced
- Specific electrode consumption is reduced by 40 to 50%

Observations

DC arc furnaces are being used sparingly in Indian steel plants in place of AC arc furnaces, although energy efficient. ESSAR Steel in India is operating with DC-EAFs. The reasons of low penetration are as follows:

- High maintenance requirements
- DC electrical equipments are critical in nature; moreover erosion of bottom electrode is fast
- Investment cost is high and technology know-how is not easily available
- Grid has to be strengthened to absorb high surge

High frequency melting furnace

It is a melting furnace for steel such as stainless steel, cast steel, nickel, other alloy steel (by direct melting method); copper, brass, aluminum, noble metals and other non-ferrous metals (by indirect melting method in which carbon or metallic crucibles are used). The principles and mechanism are:

- frequency and power are selected
- high frequency induction current, with enhanced current density which is 2 to 5 times higher than that of low frequency method, is generated. The current generates heat by internal resistance of the material, and performs melting
- steel and alloy steel are melted by resistance heat generated by the induction current that flows in steel itself
- non-ferrous metals and nonmetals are heated and melted by conduction heat from induction heating elements such as graphite and metallic crucibles

Table 3-11 below compares a high frequency melting furnace with a low frequency melting furnace:

Table 3-11: Comparison of High and Low Frequency Melting Furnaces

Low Frequency Melting Furnace	High Frequency Melting Furnace
Cannot perform rapid melting because the electric current density needs to be maintained low in view of the agitating force. As it is difficult to inject electric power to small-sized materials, melting takes longer time.	Can rapidly melt small-sized materials. This is because high frequency current can penetrate deeper, and eddy current is generated even in small sized materials
Batch type intermittent operation needs a starting block or heel	Batch type intermittent operation is possible. A starting block or heel is not needed;

Low Frequency Melting Furnace	High Frequency Melting Furnace
The equipment cost is lower than that of a high frequency furnace.	As it needs a high frequency power source; the equipment cost is higher than that of a low frequency furnace.
	With high frequency current, larger electric power can be applied, and rapid melting is possible. As radiation heat loss is small, energy is saved

Energy saving

- Saving of specific power consumption for 3 T furnace : 12.3%
- Melting speed for a 3 T furnace (kg/h): Increase by 19.5%
- Electricity 750 kW for low frequency furnace but 1500 kW for high frequency furnace.

Observations

- High frequency melting furnace has inherent advantage of high melting rate of scrap leading to improved furnace productivity. This also increases the production capacity of the shop and reduces specific cost of production.
- Many of the induction furnace operators in India are engaged in production of various types of cast irons/steels/special quality products. Adopting high frequency melting furnaces through technology transfers would be quite beneficial from energy-saving-point which reduces specific energy costs and improves bottom line.

Channel type induction furnace for cast iron melting

Induction furnaces are of two types: crucible type and channel type. Recently the channel type is more widely used because of its higher overall heat efficiency. A crucible type furnace was conventionally used for melting cast iron, using coke or low frequency non-iron core induction as a heat source. The current trend is to perform continuous operation and save energy using a channel type low frequency furnace. The comparison is given in Table 3-12 and Table 3-13.

Table 3-12: Comparison of Crucible and Channel Type of Induction Furnace

Crucible Type Induction Furnace	Channel Type Induction Furnace
The assembly of this type consists of a crucible within a water-cooled copper coil and a framework on supports arranged for tilting during pouring. The primary circuit is formed by the coil, and the secondary circuit is the crucible or, rather, the charge in it. The lines of magnetic force link through the charge and induce eddy current in it, and the later generates heat.	A closed channel furnace comprises a cylindrical shaft, made of sheet iron and lined with refractory materials, and a bottom block which is enclosed in a detachable cast shell. An inductor is placed in the central portion of the iron core in hole provided in the bottom block. The metal that fills a narrow channel in the bottom block is heated by the induced current. After being placed into the shaft, the charge is melted owing to the intensive circulation of molten metal.

Table 3-13: Comparison of Energy Saving between Crucible and Channel Type

Item	Crucible Type	Channel Type
Power efficiency	60% - 80%	95% - 97%
Overall efficiency	55% – 65%	75% - 85%
Specific power consumption	High	Low
Need of heel	Not needed	Needed
Intermittent operation	Arbitrarily possible	Principally two shift or continuous operation

Ferrous Furnace for effective energy utilization

The electric furnace for smelting HC-FeCr (high carbon ferrochromium) refines chromium ore using coke as a reducing agent. However, as the ratio of fine chromium ore increased in recent years, permeability in the electric furnace decreased, and specific consumption of electric power and coke increased. The system described here reduces energy consumption for producing HC-FeCr, and recovers the combustible gas.

When fine chromium ore is agglomerated and calcined into pellets by an annular furnace, and the pellets are charged into the EAF in place of fine chromium ore, permeability in the furnace increases, which increases the heat exchange rate among charge materials, and decreases specific power consumption. Exhaust gas from the furnace is used as fuel of the burner for pellet calcinations. Excess gas is converted to steam for internal use.

Energy saving

- Electric power, *etc.*,
- Reduction in crude oil *e.g.*, when applied to 7 EAFs of more than 1000 kVA each, reduction in crude oil eq is 80,000 t/y.

Oxy-fuel burners/lancing

Oxy-fuel burners/lancing can be installed in EAFs to reduce electricity consumption by substituting electricity with oxygen and hydrocarbon fuels. They reduce total energy consumption because of:

- Reduced heat times, which save 2-3 kWh/tonne/min of holding time
- Increased heat transfer during the refining period
- Facilitates slag foaming, which increases efficiency of oxygen usage and injected carbon

Care must be taken to use oxy-fuel burners correctly, otherwise there is the risk that total energy consumption and greenhouse gases will increase.

Energy saving

- Electricity savings of 0.14 GJ/tonne crude steel, typical savings range from 2.5 to 4.4 kWh per Nm³ oxygen injection with common injection rates of 18 Nm³/t.

- Natural gas injection is 10 scf/kWh (0.3 m³/kWh) with typical savings of 20 to 40 kWh/T
- Retrofit Capital Costs of \$4.80/T crude steel on an EAF of 110 tonnes
- Improved heat distribution leads to reduced tap-to-tap times of about 6%, leading to estimated annual cost savings of \$4.0/T
- Reduction of nitrogen content of the steel, leading to improved product quality

Scrap preheating

Scrap preheating is a technology that can reduce the power consumption of EAFs through from using the waste heat of the furnace to preheat the scrap charge. Old (bucket) preheating systems had various problems, *e.g.*, emissions, high handling costs, and a relatively low heat recovery rate. Modern systems have reduced these problems and are highly efficient. The energy savings depend on the preheat temperature of the scrap. Various systems have been developed and are in use at various sites in the U.S. and Europe, *i.e.*, Consteel tunnel-type preheater, Fuchs Finger Shaft, and Fuchs Twin Shaft. All systems can be applied to new constructions, and also to retrofit existing plants.

A. Tunnel furnace - CONSTEEL process

The Consteel process consists of a conveyor belt with the scrap going through a tunnel, down to the EAF through a “hot heel”. Various U.S. plants have installed a Consteel process, as well as one plant in Japan.

Energy/Environment/Cost/Other Benefits Consteel process:

- Productivity increase of 33%
- Reduced electrode consumption of 40%
- Reduced dust emissions
- Electricity savings estimated to be 60 kWh/t for retrofits
- Annual operating cost savings of \$1.90/t crude steel (including productivity increase, reduced electrode consumption, and increased yield)
- Retrofit Capital Costs \$4.4 to \$5.5/t (\$2M for a capacity of 400,000 to 500,000 t/year)

B. Post consumption shaft furnace (FUCHS)

The FUCHS shaft furnace consists of a vertical shaft that channels the off-gases to preheat the scrap. The scrap can be fed continuously or through a so-called system of ‘fingers’. The optimal recovery system is the ‘double shaft’ furnace, which can only be applied for new construction. The Fuchs-systems make almost 100% scrap preheating possible, leading to potential energy savings of 100-120 kWh/t. Carbon monoxide and oxygen concentrations should be well controlled to reduce the danger of explosions, as happened at one plant in the U.S.

Energy saving

- Electricity savings of 120 kWh/t and fuel increases of 0.7 GJ/t
- Annual operating cost savings of \$4.5/t (excluding saved electricity costs)
- Retrofit Capital Costs of about \$6/t crude steel for and existing 100 t furnace

- Reduced electrode consumption
- Yield improvement of 0.25-2%
- Up to 20% productivity increase
- 25% reduced flue gas dust emissions (reducing hazardous waste handling costs)

Electrochemical dezincing

Dezincing of steel scrap improves recycling process. This electrochemical dezincing process provides an environmental friendly, economic method of removing zinc from steel scrap to reuse both the steel and zinc. With the use of zinc coated prompt scrap increasing, steelmakers are feeling the effect of increased contaminant loads on their operations. The greatest concerns are the cost of treatment before disposal of waste dusts and the water associated with remelting zinc coated scrap.

The process consists of two basic steps:

- dissolving the zinc coating from scrap in a hot, caustic solution, and
- recovering the zinc from the solution electrolytically.

Through a galvanic process, the zinc is removed from the steel and is in solution as sodium zincate ions rather than zinc dust. The steel is then rinsed with water and ready for reuse. Impurities are removed from the zinc solution, and then a voltage is applied in order to grow metallic zinc via an oxidation reduction reaction. All waste streams in this process are reused.

Benefits

- Pollution Reduction – Removal of zinc decreases steelmaking dust released to the air as well as pollutants in wastewater streams. The process itself does not consume any chemicals (other than drag out losses) and produces only a small amount of waste.
- Productivity – Removing zinc prior to processing of scrap saves time and money in disposal of waste dusts and water. Without the zinc, this high quality scrap does not require extra handling, blending, or sorting for remelting in steelmaking furnaces.

Divided blast cupola

Divided blast cupola (DBC) is a well-proven technology for improving the energy performance at a modest investment. A DBC supplies blast air to the cupola furnace at two levels through a double row of tuyeres almost equally divided between the top and bottom row of tuyeres, and the spacing between the tuyeres is about one metre apart, irrespective of the diameter of the cupola. Some comparative advantages of a DBC, as found in studies conducted by BCIRA, are given below:

- a higher metal tapping temperature (approximately 45-50°C more) and higher carbon pick-up (approximately 0.06%) are obtained for a given charge-coke consumption
- charge-coke consumption is reduced by 20-32% and the melting rate is increased by 11-23%, while maintaining the same metal tapping temperature

However, in the initial survey conducted at Agra and Howrah foundry clusters, it was found that conventional cupolas are commonly used by Indian foundry units and DBCs, where ever adopted, are of sub-optimal designs. Hence the intervention aims to

demonstrate and disseminate the benefits of a well - designed DBC among Indian foundries.

TERI's DBC design

TERI's DBC design incorporates the specific melting requirements of the individual foundry unit. Salient features of the cupola design include:

- Optimum selection of blower specifications (quantity and pressure)
- Optimum ratio of the air delivered to the top and bottom tuyers
- Minimum pressure drop and turbulence of the combustion air
- Separate wind-belts for top and bottom tuyeres
- Correct tuyere area, tuyere number and distance between the two rows of tuyeres
- Optimum well capacity
- Higher stack height
- Mechanical charging system
- Stringent material specifications

Energy savings and other benefits

A demonstration plant was installed at Bharat Engineering Works, Howrah, a unit nominated by the Indian Foundry Association (IFA). The foundry, manufacturing ingot moulds, had a charge coke percentage of 13.6 % (coke:metal :: 1:7.5) which was brought down to 8 % (coke:metal :: 1:12.5). Hence, the energy saving achieved in the new plant was about 40 % compared to their earlier cupola. On an average monthly melting of 430 tonnes, the yearly saving in coke is 270 tonnes which is equivalent to Rs. 8 lakh.

Additionally there was an increase in metal tapping temperature and reduction in silicon and manganese losses.

Energy saving of about 40 % was achieved in a replication unit setup at a foundry unit in Nagpur which makes thin-walled sanitary castings. The charge coke consumption reduced from 22 % (coke:metal :: 1:4.5) earlier to about 13 % (coke:metal :: 1: 7.7). This translates to a coke saving of 280 tonnes per annum (TPA) worth about Rs. 11 lakh on a melting of 300 tonnes per month in the foundry. The total capital investment of the cupola, inclusive of civil work, platforms, bucket charging system *etc.*, was about Rs. 12 lakhs. Thus the payback on the investment is one year considering savings in coke only. Additional benefits of DBC were – better analytical and temperature control of molten metal leading to substantial reduction in rejection of finished castings. The payback is more attractive, if the decrease in rejection rate of finished casting on account of better analytical and temperature control is considered

Pollution control technologies

EAF

In EAF operation, scarp, reduced iron and now-a-days hot metal is charged from the top into a refractory and water panel lined chamber. Swing roof, which is also lined with

refractory and water-cooled panel, is placed over the chamber. Through the roof three graphite electrodes are placed and connected to a powerful AC transformer which supplies the power necessary to melt the charge using high power arc discharge. The fume generated during the operation is aspirated through the fourth hole in the roof by creating a vacuum of about 1.5 to 2.5 mm H₂O inside the EAF casing, which is known as primary air. In-leakage air enters the casing through door openings, gaps of electrode holes, chute, *etc.* and decarburizes carbon. Additional oxygen may be supplied for complete decarburization of charge. The air rich in CO at a temperature of around 1700°C then passes through double-walled water-cooled elbow. Additional air is aspirated to combust balance CO to CO₂ from elbow gap. Hot gases are cooled through a water-cooled duct to around 550-600°C and then by a forced draft cooler before entering the bag filter at 120 – 130°C. If needed, additional air is sucked to the system. The bag filter is normally pulse jet type. Wet scrubbers were used earlier.

During charging, considerable amount of fugitive emissions arise which may be sucked through roof mounted canopy of adequate size. The quantity of suction air may be 10-15 times more than that of the primary air. This air may be added to the gas collection system through a mixing chamber, which also serves as a spark arrester, to cool the gases and taken to the bag filter to avoid installation of additional bag filter system. The canopy hood needs to suck less air during melting when the roof is closed and can be manipulated by a damper.

In many cases, especially in case of smaller capacity furnaces and high alloy steel making furnaces, where a small positive pressure is required in the furnace to create reducing condition, it would be advantageous to control the emissions by means of a side draft hood placed above the furnace roof or only by a roof mounted canopy, though its effectiveness is less. If the EAF is provided with a ladle refining unit, gases may be sucked from the refining ladle through a water-cooled duct and connected to the same system at mixing chamber.

The dust from the bag filter unit and mixing chamber is conveyed to a dust silo by mechanical or pneumatic conveying system. The dust is processed through a pug mill or pelletized before its final disposal/reuse. Dust recycling in the rotary hearth furnace (RHF) was applied at Nippon Steel's Kimitsu Works in 2000. The dust and sludge, in case of wet cleaning, along with iron oxide and carbon, are agglomerated into shaped articles and the iron oxide is reduced at high temperatures. Zinc and other impurities in the dust and sludge are expelled and exhausted into off-gas. Asahi Kyogyo in June 2007 used RHF to recycle 10,000 TPA EAF dust to EAF as DRI. So far, the EAF dust and slag are not being recycled or utilized in any way in the Indian steel works. These two by-products are being dumped. There is pressure from the regulatory body for alternate use of EAF dust as these are hazardous in nature. Pelletising of EAF dust is generally not practiced in Indian Electric Furnace steel making.

Induction furnace

From the description of pollution potential from induction furnaces, it may be observed that volume, quantity and harmful emission of solid and gaseous contaminants are fairly low as compared to EAF. The equipment need not be as elaborate as EAF so as to make it cost-effective for small-scale induction furnace units. At the same time, the pollutants emitted should be in conformity to regulations. The steps involved are: extraction of fumes; cleaning by cyclone separator; further cleaning of finer particulates in wet scrubber; and then allowing clean gases to pass to the environment. The last step is disposal of solid matter left as sludge or dust.

Cupola furnace

Emission reduction efforts include the use of bag houses, venturi scrubber, wet scrubbers, and afterburners to reduce particulates, CO and VOCs in cupola off-gases. Fabric filters are most effective in controlling cupola emissions, reducing manganese emissions from 250,000 to 300 mg/Mg. High energy scrubbers, impingement scrubbers and wet caps are used with less favorable results. Use of gas for heat and graphite for carbon may reduce emissions due to coke, which contributes to organics and trace inorganics.

The venturi scrubber is a highly efficient device for removing particulate matter and sulphur dioxide from stack gases. Since cupola stack gases contain a significant percentage of fine particulates, it was found that a venturi scrubber was the most effective device to bring down the emissions below the more stringent PEL of 150 mg/Nm³. Lime dosing can be done to maintain the pH of the recirculating water and reduce SO₂.

SPM and sulphur dioxide of the outlet gas from the pollution control device was measured which was installed at a foundry in Howrah. The SPM was found to be about 50 mg/Nm³ and sulphur dioxide was measured to be about 40 mg/Nm³.

Low cost wet scrubber dust emission control

National Productivity Council, Chennai has conducted a detailed investigation of the emissions from the cupola furnaces at Coimbatore. A low-cost wet scrubber system was designed and implemented by the units to control the dust emissions. It is a simple fabricate and install online process. No operator attention is necessary for scrubber operation. A water spray wet scrubber is designed concurrent to gas flow rate at the exit of the cupola furnace (Figure 3-9). The natural draft created (300°C – 400°C) by the cupola furnace is sufficient to draw the gases through the scrubber and there is no additional ID fan is necessary. A set of water spray nozzles scrub the dust laden gases. However to create additional draft to the cooled gases to discharge into atmosphere, an extended stack of diameter 1.0 ft and 6 ft high is installed at the exit of the scrubber. The scrubber water is collected in a sump to allow settling and separate the sludge and the clear water is re-circulated to the scrubber by 1HP centrifugal pump. Periodically the settled sludge is collected dried and disposed.

The water loss due to evaporation and along with sludge is about 5 m³ for 8 hours operation of cupola. The operating cost is only the power consumption by the recirculating pump, which is about < 10 units per day. The cost of the system is about Rs 70,000/- to Rs 80,000/-.



Figure 3-9: Low Cost Scrubber

Performance efficiency of the wet scrubber

The performance efficiency of the scrubber was assessed by collecting stack emission dust samples from the sampling port provided at the extended stack. Following are the emission monitoring results:

Table 3-12: Emission Monitoring Results

S. No	Parameter	Designed values	Measured values	Emission Standard by TNPCB
1	Flow rate of gases, Nm ³ /hr	3000	2,300	-
2	Dust emissions after the scrubber, mg/Nm ³	< 150	47	150
3	Sulphur dioxide concentration, mg/Nm ³	300 - 400	< 50	-

REFERENCES

Documents

- **Ministry of Environment and Forest, GoI** – “Environment Impact Assessment Notification” S.O.1533 dated 14th September 2006.
- **Ministry of Environment and Forest, GoI** – “Environment Impact Assessment Notification 2006 – Amendment” S.O. 195 (E) dated 1st December, 2009.
- **Ministry of Environment and Forest, GoI** – Charter on Corporate Responsibility for Environment Protection Action Points for 17 Categories of Industries, CPCB, March 2003.
- **Ministry of Environment and Forest, GoI** – Environment (Protection) Act,
- **Larry W. Canter**, “Environmental Impact Assessment”, Second Edition, McGraw Hill, University of Oklahoma, 1997.
- **European Commission - Integrated Pollution Prevention and Control (IPPC):** Best Available Techniques Reference Document on the Production of Iron and Steel December 2001.
- **International Association for Impact Assessment** – “Principles of Environmental Impact Assessment Best Practice”, Institute of Environmental Assessment, UK.
- **International Finance Corporation** – “Environmental, Health and Safety Guidelines for Integrated Steel Mills”, World Bank Group, April 30, 2007.
- **World Bank Group** – “Pollution Prevention and Abatement Handbook on Coke Manufacturing” effective July 1998.
- **World Bank Group** – “Pollution Prevention and Abatement Handbook on Copper smelting” effective July 1998.
- **World Bank Group** – “Pollution Prevention and Abatement Handbook on Aluminum Manufacturing” effective July 1998.
- **World Bank Group** – “Pollution Prevention and Abatement Handbook on Iron and Steel Manufacturing” effective July 1998.
- **World Bank Group** – “Pollution Prevention and Abatement Handbook on Lead and Zinc Smelting” effective July 1998.
- **World Bank Group** – “Pollution Prevention and Abatement Handbook on Mini steel Mills” effective July 1998.
- **World Bank Group** – “Pollution Prevention and Abatement Handbook on Nickel Smelting and Refining” effective July 1998.
- **World Bank Group** – “Environmental, Health and Safety Guidelines, Base Metal Smelting and Refining, April 30, 2007

- *A Text Book of Metallurgy*, A.R.Baily, MacMilan and Company Limited, 1967
- *“Added Value Long Steel Products produced at MSSA Newcastle Works”* – V. Scholtz, D.S. Magudulela, F. van Zyl, A. Coetzee, A. Humpel, C. Hill, and A.J. Potgieter.
- *Air Pollution Engineering Manual (Environmental Engineering)* – by Anthony J. Buonicore (Hardcover - Jun 1992)
- *Coke Production For Blast Furnace Ironmaking* – By Hardarshan S. Valia, Scientist, Ispat Inland Inc
- *Dust and Fume Generation in the Iron and Steel Industry*, S.Andonyev et.al., Mir Publisher, Moscow,1978
- *Egyptian Environmental Affairs Agency (EEAA) Egyptian Pollution Abatement Project (EPAP)* – “Self-Monitoring Manual Secondary Metallurgical Industry: by Dr. Mohamed Abdel Hamid El Refaai Faculty of Engineering – Al Azhar University.
- *Environmental and Waste Management in Metallurgical Industries*, NML, Jamshedpur, February 1996.
- *General Metallurgy*, N. Sevryukov et.al., Mir Publishers, Moscow,1969
- *JPC Bulletin on Iron & Steel (JPC)*, Ministry of Steel, Government of India, January 2007 & June 2008
- *Multilateral Investment Guarantee Agency* – “ Environmental Guidelines for Coke Manufacturing”
- *National Seminar on Environmental Pollution and Control in Secondary Steel Sector*, NISST, New Delhi, 1996
- *Products and by-products of Coal* – By Edger stansfield
- *Sector Notebook Project*, USEPA; SIC Code 333-334, September 1995.
- *State-of-the-Art Clean Technologies (SOACT) for Steel Making Handbook*, Asia Pacific Partnership On Clean Development And Climate (APPCD), December 2007
- *Technological Development in Metallurgical Industries, Focus: Iron Making and Steel Making*, MECON, September 2007
- *T.K.Mukherjee, Processing of Secondary Resources for Sustainable Development in the Metallurgical Industry*, IIM Presidential Address, 2004.
- *Environmental Management System Implementation Guide for the Electric Arc Furnace Iron & Steel Industry: Sector Strategies Program of the U.S. Environmental Protection Agency (EPA).*
- *Environmental Management System Guide: Steel Manufacturers Association*
- *Environmental Impact Assessment of Thai Iron and Steel Factory: International Conference on Sustainable Architectural Design and Urban Planning, Hanoi Architectural University (Vietnam), 2007.*

Websites

- <http://beta.deq.virginia.gov/export/sites/default/air/pdf/airregs/448.pdf>
- <http://dsp-psd.pwgsc.gc.ca/Collection/C45-2-3-2000-2E.pdf>
- <http://ecm.ncms.org/ERI/new/IRRironsteel.htm#issues>
- <http://envfor.nic.in/divisions/iass/eia.htm>
- <http://gissserver.nic.in/ecprocess/ECProcess/10.htm>
- <http://www.bhamrails.info/index.htm>
- <http://www.cfriindia.nic.in/>
- <http://www.cpcb.nic.in/>
- <http://www.epa.gov/>
- <http://www.epa.gov/ttn/chief/ap42/ch12/>
- <http://www.epa.gov/ttnchie1/ap42/ch12/index.html>
- <http://www.epa.gov/Compliance/resources/publications/assistance/sectors/notebooks/nonferrous.html>
- <http://www.iaia.org>
- http://www.minsocam.org/MSA/collectors_corner/article/oremin.htm
- <http://www.osha.gov/SLTC/etools/leadsmelter/index.html>
- <http://www.scribd.com/doc/7278475/Sponge-Iron-Report>
- www.wikipedia.org
- www.epa.gov/sectors



IL&FS Ecosmart Limited
Flat # 408, Saptagiri Towers
Begumpet

Hyderabad – 500 016

Ph: + 91 40 40163016

Fax: + 91 40 40032220

For any queries or technical inputs kindly mail:

sateesh.babu@ifsecosmart.com

suman.thomas@ifsecosmart.com